



IL BAGNO **ALESSI**

**One**

design Stefano Giovannoni  
(2002, 2010, 2014)

**LAUFEN**

Bathroom Culture since 1892  [www.laufen.com](http://www.laufen.com)



MIRROR 120 • 4.4843.1  
WASHBASIN 120 • 8.1497.4  
VANITY UNIT 100 • 4.2450.0

# ILBAGNOALESSI

## One

design Stefano Giovannoni  
(2002, 2010, 2014)

Born in 2002 from the creativity of famous Italian designer Stefano Giovannoni, IIBagnoAlessi One is one of Laufen's most successful collections. Based in 15 years of successful co-operation between Laufen and Alessi, the range is one of the most complete and sustainable ever produced on an industrial scale. The IIBagnoAlessi One collection is continuously being enriched with new elements and designs, from countertops and freestanding washbasins to bathtubs, from toilets to the furnishings and accessories made in our world class SaphirKeramik.

Laufen, global leader in designer sanitary ware, has always combined its solid commitment to crafting the highest quality products with its passion for experimentation and its great capacity for technological innovation. At all stages Laufen uses exceptional raw materials and highly skilled labour.

The additional IIBagnoAlessi One range recognises the increasing importance of great design for compact spaces, offering solutions that provide comfort and style in smaller environments as well as in more spacious interiors.

The creative and inspiring IIBagnoAlessi One collection is a highly innovative and growing project, which, according to Alberto Alessi, "Stefano was able to freely and adroitly draw from the extensive vocabulary of forms that have been made available to human kind, creating objects that are at once more striking and more human".

IIBagnoAlessi One wurde im Jahr 2002 vom italienischen Star-Designer Stefano Giovannoni entworfen und ist eine der erfolgreichsten Kollektionen in der 15-jährigen Zusammenarbeit zwischen Laufen und Alessi. Sie setzt Massstäbe hinsichtlich Vielfalt und Langlebigkeit der Produkte und wird regelmässig in alle Richtungen erweitert: von Waschbecken zu Badewannen, von WCs zu weiterer Badezimmer-Einrichtung und Zubehör, alles gefertigt aus dem einzigartigen SaphirKeramik Material.

Schon immer verbindet Laufen, das weltweit führende Unternehmen für Baddesign, höchstes Engagement bei der Entwicklung und Produktion seiner hochwertigen Produkte mit seiner klaren Berufung zum Experimentieren. Dies wird erreicht durch kontinuierliche Erforschung neuer Rohstoffe und hohe Ansprüche an die Spezialisierung und Qualifizierung der Mitarbeiter.

Die Erweiterung zu IIBagnoAlessi One bietet Produkte auch in kleineren Grössen an und trägt damit der aktuellen Entwicklung hin zu kleineren Badezimmern Rechnung. Damit werden Komfort und Design auch in kompakteren Räumen ermöglicht.

Dank langjähriger Erfahrung in der Keramikherstellung und der kontinuierlichen, kreativen Kraft stellt die Kollektion IIBagnoAlessi One ein extrem innovatives, expandierendes Projekt dar, das laut Alberto Alessi auf der besonderen Fähigkeit von Giovannoni basiert, „geschickt aus dem umfangreichen Formenvokabular zu schöpfen, das dem Menschen zur Verfügung steht, um immer humanere und einprägsamere Badobjekte zu entwerfen.“

Née en 2002 de la créativité du célèbre designer italien Stefano Giovannoni, IIBagnoAlessi One est l'une des collections les plus appréciées de la marque et parmi les plus complètes et durables jamais réalisées à l'échelle industrielle. La gamme, qui continue de s'agrandir au fil des ans avec de nouveaux éléments, s'étend à tous les niveaux: des lavabos à poser et indépendants aux baignoires, des sanitaires jusqu'aux éléments d'ameublement et aux accessoires en SaphirKeramik.

Depuis toujours, Laufen, l'entreprise suisse leader dans la fabrication de sanitaires design, maîtrise un savoir-faire dans le développement de produits de grande qualité grâce à la recherche de l'excellence dans le choix de ses matériaux et à l'emploi d'une main-d'œuvre hautement qualifiée, avec pour vocation l'innovation constante et la capacité de se maintenir à la pointe de la technologie.

Une attention toute particulière a d'ailleurs été récemment portée sur les contraintes posées par un environnement aux espaces de plus en plus restreints. Pour y remédier: des éléments aux dimensions réduites et permettant d'allier confort et design, même dans les plus petits espaces. Fruit du savoir-faire dans la fabrication de céramique et dans un désir de créativité sans cesse renouvelée, la collection IIBagnoAlessi One est le pilier d'un projet en pleine expansion et à forte valeur innovante. Comme

Alberto Alessi souligne: "Stefano a été capable de créer des objets qui sont à la fois plus impactant et plus humains".

Nato nel 2002 dalla creatività del noto designer italiano Stefano Giovannoni, IIBagnoAlessi One è una delle collezioni di maggior successo dell'azienda, nonché una tra le proposte più complete e longeve mai realizzate su scala industriale. La gamma, che continua a crescere arricchendosi nel corso degli anni di sempre nuovi elementi, spazia in ogni direzione: dai lavabi consolle e free standing alle vasche da bagno, dai sanitari fino ai complementi d'arredo e agli accessori in SaphirKeramik.

Da sempre Laufen, azienda svizzera leader nel bagno di design, coniuga il grande impegno nello sviluppo di prodotti di altissima qualità, possibile grazie alla ricerca dell'eccellenza nelle materie prime e all'impiego di manodopera altamente specializzata, con la sua chiara vocazione alla sperimentazione e la sua grande capacità di innovazione tecnologica.

Grande attenzione è stata recentemente posta, inoltre, nei confronti delle necessità determinate da ambienti sempre meno ampi, proponendo anche elementi in dimensioni ridotte e permettendo così di avere comfort e design anche in piccoli spazi.

Frutto del know-how nella produzione di ceramiche e del costante sforzo creativo, la collezione IIBagnoAlessi One rappresenta un progetto in espansione fortemente innovativo. Come sottolinea Alberto Alessi, "Stefano ha saputo attingere con libertà e maestria al grande vocabolario delle forme che sono state messe a disposizione dell'uomo per creare degli oggetti insieme più emozionanti e più umani".



BATHTUB 180 • 2.4597.2  
MIRROR 120 • 4.4843.1  
WASHBASIN BOWL 80 • 8.1897.3  
WASHTOP 120 • 4.2311.1  
DRAWER ELEMENT 40 • 4.2440.2  
WALLHUNG BIDET • 8.3097.1  
SAPHIRKERAMIK TOILET PAPER HOLDER • 8.7097.0  
WALLHUNG WC • 8.2097.6  
SEAT AND COVER • 8.9297.1

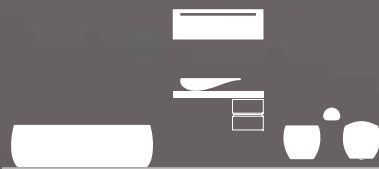







Solid Surface, freestanding bathtub in soft and comfortable shapes, with or without whirl system. Also available in a fitted version.

Freistehende Badewanne aus Mineralgusswerkstoff in sanfter, komfortabler Form, mit oder ohne Whirlsystem. Auch als Einbauversion erhältlich.

Baignoire indépendante en Solid Surface aux formes délicates et harmonieuses, avec ou sans système balnéo. Également disponible en version encastrable.

Vasca centro stanza in Solid Surface dalle forme morbide e avvolgenti, con o senza idromassaggio. Disponibile anche nella versione da incasso.



The washbasin icon of this collection is now also available in a 90cm and 120cm left or right countertop version, especially suitable for smaller spaces.

Der ikonische Waschtisch aus der Kollektion ist auch als unterbaufähiger Waschtisch links oder rechts von 90 cm oder 120 cm erhältlich, besonders für kleinere Räume geeignet.

Le lavabo, élément phare de la collection, désormais est aussi disponible en version encastrable gauche ou droite de 90 cm et 120 cm, particulièrement adaptée à de plus petits espaces.

Il lavabo icona della collezione è ora disponibile anche nella versione consolle destra o sinistra da 90 cm e 120 cm, particolarmente adatta a spazi più piccoli.

MIRROR CABINET 65 • 4.4812.1  
WASHBASIN 90 • 8.1497.5  
VANTIY UNIT 73 • 4.2447.0





Eye-catching design: 400 mm high "half Tam Tam".  
The free-standing washbasin bowl makes a great impression.

Zieht Blicke auf sich: Der 400 mm hohe „halbe Tam Tam“.  
Als freistehende Waschtischschale hinterlässt er einen starken Eindruck.

Attire tous les regards: le «semi Tam Tam» haut de 400 mm.  
Utilisé comme lavabo à poser non encastré, il fait forte impression.

Un mobile che attira tutti gli sguardi: il "mezzo Tam Tam" alto 400 mm.  
Questa bacinella per centro stanza esercita un forte impatto visivo.





MIRROR 160 • 4.4844.1  
HALF TAM TAM • 8.1197.3  
WASHTOP 160 • 4.2321.1  
VANITY UNIT 80 • 4.3021.1







- BATHTUB 180 • 2.4597.2
- MIRROR 2x120 • 4.4843.1
- WASHBASIN BOWL 80 • 8.1897.3
- VANITY UNIT 240 • 1x4.2460.4 / 2x4.2417.0
- SAPHIRKERAMIK HANGER • 8.7097.6
- WALLHUNG BIDET • 8.3097.1
- SAPHIRKERAMIK TOILET PAPER HOLDER • 8.7097.2
- WALLHUNG WC • 8.2097.6
- SEAT AND COVER • 8.9297.1

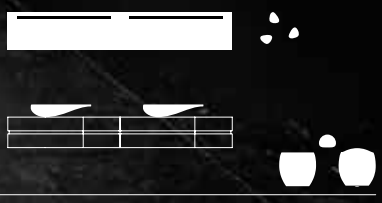



# “Like the idea of a white stone polished by water”

Stefano Giovannoni



WASHBASIN BOWL 80 • 8.1897.3  
VANITY UNIT 120 • 4.2416.1





MIRROR FRAME 200 • 4.4742.0  
LAMP, HORIZONTAL 200 • 4.4756.2  
SAPHIRKERAMIK SHELF  
TOWEL HOLDER • 8.7097.2  
WASHBASIN BOWL 80 • 8.1897.3  
WASHTOP 200 • 4.2325.4  
BATHTUB 180 • 2.4597.2



# “Objects that are at once more striking and more human”

Alberto Alessi



WASHBASIN 120 • 8.1497.6  
VANITY UNIT 120 • 8.2445.0

SAPHIRKERAMIK SHELF TOWEL HOLDER • 8.7097.2







The collection is enriched with new accessories with functional and symbolic value, including a towel shelf made of the revolutionary SaphirKeramik. Also available are a toilet paper holder and a towel hook.

Die Kollektion wird durch neue Accessoires von funktionalem und symbolischen Wert ergänzt, unter anderem durch die Ablage mit Handtuchschlitz, gefertigt aus der revolutionären SaphirKeramik. Erhältlich sind auch Papierrollenhalter und Aufhänger.

La collection s'enrichit de nouveaux accessoires à la portée autant symbolique que fonctionnelle, comme l'étagère avec porte-serviette en céramique révolutionnaire, la SaphirKeramik. Sont également disponibles le porte-rouleau WC et le crochet.

La collezione si arricchisce di nuovi accessori dal valore e funzionale e simbolico, tra cui la mensola con portasciugamani realizzata con la rivoluzionaria SaphirKeramik. Disponibili anche il portarotolo e il gancio portasciugamani.



URINAL • 8.4097.1  
COVER • 8.9497.1



SAPHIRKERAMIK HANGER • 8.7097.6  
SAPHIRKERAMIK TOILET PAPER  
HOLDER • 8.7098.0  
SIPHONIC ONE PIECE WC • 8.2397.0  
SEAT AND COVER • 8.9297.1

WALL-HUNG BIDET • 8.3097.1  
SAPHIRKERAMIK TOILET PAPER  
HOLDER • 8.7098.0  
WALL-HUNG WC • 8.2097.6  
SEAT AND COVER • 8.9297.1











BATHTUB 180 • 2.4597.2  
 HIGH CABINET 170 • 4.5801.2  
 MIRROR 120 • 4.4843.1  
 WASHBASIN 120 • 8.1497.4  
 VANITY UNIT 100 • 4.2450.0  
 SAPHIRKERAMIK HANGER • 8.7097.6  
 FLOORSTANDING WC COMBINATION • 8.2297.6  
 SAPHIRKERAMIK TOILET PAPER HOLDER • 8.7098.0  
 SEAT AND COVER • 8.9297.1



# “Il Bagno Alessi One” really seems to be a timeless archetype, fashionable yet not following any particular style, like something created by nature itself”

Stefano Giovannoni



Born in La Spezia (Italy) in 1954, architect and designer Stefano Giovannoni now lives and works in Milan.

His internationally acclaimed, multi-award winning work, some of which can be found in the permanent collections of the Centre Georges Pompidou in Paris and the Museum of Modern Art in New York. For Alberto Alessi, the managing director of ALESSI, Giovannoni is one of the few designers capable of combining the extraordinary with the popular.

This is indeed the reason that he commissioned him to develop ALESSI's first complete bathroom scenario.

Der 1954 in La Spezia (Italien) geborene Architekt und Designer Stefano Giovannoni lebt und arbeitet in Mailand. Sein Schaffen wurde mehrfach international ausgezeichnet. Einige seiner Werke finden sich in den permanenten Sammlungen des Centre Georges Pompidou in Paris sowie des Museum of Modern Art in New York. Für Alberto Alessi, den Geschäftsführer von ALESSI, ist Giovannoni einer der wenigen Designer, die es verstehen, das Aussergewöhnliche mit dem Populären zu verbinden. Das ist auch der Grund, weshalb er ihn mit der Entwicklung des ersten kompletten Badezimmerszenarios für ALESSI beauftragte.

L'architecte et designer Stefano Giovannoni, né en 1954 à La Spezia (I), vit et travaille à Milan. Ses oeuvres ont maintes fois été reconnues sur le plan international. Quelques-unes de ses créations sont exposées dans des collections permanentes au Centre Georges Pompidou à Paris et au Museum of Modern Art à New York. Pour Alberto Alessi, directeur d'ALESSI, Giovannoni est l'un des rares designers en mesure de relier l'exceptionnel au populaire. C'est aussi la raison pour laquelle il l'a chargé de développer le premier concept complet de salle de bains pour ALESSI.

L'architetto e designer Stefano Giovannoni, nato a La Spezia (I) nel 1954, vive e lavora a Milano. Le sue creazioni sono state più volte premiate a livello internazionale. Alcune delle sue opere fanno parte della collezione permanente del Centre Georges Pompidou a Parigi e sono esposte al Museum of Modern Art di New York. Per Alberto Alessi, titolare di ALESSI, Giovannoni è uno dei pochi designer in grado di combinare quanto c'è di più straordinario con gli aspetti più popolari. E questo è anche il motivo per cui lo ha incaricato della creazione della prima collezione completa per il bagno di ALESSI.





WASHBASIN 160 • 8.1497.1





This washbasin ripples like a wave over the furniture element. Its ceramic shelf provides an easy-to-clean storage area for bottles and soap. With hidden overflow hole, with or without tap hole.

Wie eine Welle flutet dieser Waschtisch über das zugehörige Möbel. Seine keramische Ablage lässt sich als reinigungsfreundliche Stellfläche für Flakons und Seifen verwenden. Mit verstecktem Überlauf, mit oder ohne Hahnloch.

Ce lavabo vient lécher telle une vague le meuble correspondant. Sa tablette en céramique s'utilise comme surface de pose facile à nettoyer pour les flacons et les savons. Avec trop-plein caché, avec ou sans trou pour la robinetterie.

Questo lavabo fluttua come un'onda sul mobiletto sottostante. La sua mensola in ceramica, facile da pulire, è l'ideale per riporvi flaconi e sapone. Con troppopieno nascosto, con o senza foro per la rubinetteria.



MIRROR 160 • 4.4844.1  
WASHBASIN 160 • 8.1497.1  
VANITY UNIT 130 • 4.2436.0





The visual anchor and keynote design element of ILBAGNOALESSI One is the floorstanding washbasin, affectionately called Tam-Tam – for its likeness to a drum. Also available with wall-connection and as a “half Tam-Tam” washbasin bowl.

Der visuelle Anker und das bestimmende Design-Element von ILBAGNOALESSI One ist der bodenstehende Waschtisch, liebevoll Tam-Tam genannt – ähnelt er doch einer Trommel. Auch erhältlich mit Wandanbindung und als “halb Tam-Tam” Aufsatz-Waschtisch.

TAM TAM • 8.1197.2







HALF TAM TAM • 8.1197.3  
WASHTOP 160 • 4.2321.2



Le lavabo au sol, affectueusement surnommé Tam-Tam, est l'ancrage visuel et l'élément déterminant du design de ILBAGNOLESSI One, même s'il ressemble à un tambour. Disponible aussi avec raccordement au mur et en version vasque à poser "demi Tam-Tam".

Icona del design é il lavabo centro stanza, confidenzialmente chiamato Tam-Tam, per la sua somiglianza con lo strumento musicale. Disponibile anche con connessione a parete e come bacinella "mezzo Tam-Tam".



BATHTUB 200 • 2.4197.0  
MIRROR 160 • 4.4844.1  
HALF TAM TAM • 8.1197.3  
WASHTOP 160 • 4.2321.4 + 4.2300.0







MIRROR 160 • 4.4844.1  
SEMI-RECESSED WASHBASIN 75 • 8.1397.2  
VANITY UNIT 120 • 4.2415.2  
VANITY UNIT 120 • 4.2415.1

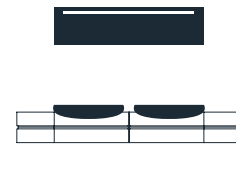



DROP-IN WASHBASIN 50 • 8.1397.1  
VANITY UNIT 120 • 4.2414.2



WALLHUNG BIDET • 8.3097.1  
WALLHUNG WC • 8.2097.6







IlBagnoAlessi One washbasin bowls elegantly combine with the vanity units with drawers and mirror cabinets.

Die Aufsatz-Waschtische aus der Kollektion IlBagnoAlessi One sind mit dem Unterbau und Schubladen und dem Spiegelschrank elegant kombinierbar.

Les vasques à poser de la collection IlBagnoAlessi One s'intègrent de manière élégante aux meubles de lavabos avec tiroirs et aux meubles à miroir.

Le bacinelle della collezione IlBagnoAlessi One si abbinano elegantemente alle basi con cassetti e agli specchi contenitori.





MIRROR CABINET 65 • 4.4811.1 + 4.4812.1  
WASHBASIN BOWL 75 • 8.1897.2  
WASHTOP 240 • 4.2462.4  
VANITY UNIT 120 • 4.2418.0  
VANITY UNIT 120 • 4.2417.0

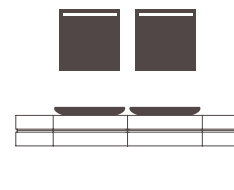



MIRROR 160 • 4.4844.1  
WASHBASIN 160 • 8.1497.1  
BATHTUB 200 • 2.4497.0  
BATHTUB BENCH 320 • 4.5851.2



The specially designed furniture for the sanitary acrylic bathtub in real wood veneer noce canaletto completes the bathroom range, with possible extensions on both sides and specially treated against water. Also available in white, the top plate is made of artificial marble.

Die speziell designte Ausstattung für die Acryl- Badewanne in Echtholz furnier Noce Canaletto, mit möglichen Erweiterungen auf beiden Seiten und speziell wasserabweisender Oberfläche, vervollständigt die Badezimmereinrichtung. Auch in Weiss, mit Oberplatte aus Kunstmarmor erhältlich.

Pour compléter l'ensemble de la salle de bains, le meuble conçu pour la baignoire en acrylique sanitaire est en plaqué noce canaletto, spécialement traité contre les moisissures, avec des extensions de chaque côté. Également disponible en blanc, la plaque supérieure est en marbre artificiel.

Il mobile in noce canaletto, appositamente disegnato per la vasca in acrilico sanitario, con possibili estensioni su entrambi i lati e trattato con una speciale vernice resistente all'acqua, completa la gamma degli arredi. Disponibile anche in bianco, con il top in marmo tecnico.



“The overall bathroom setting  
is much more than just a place  
where we clean our bodies”

Alberto Alessi



WASHBASIN 160 • 8.1497.1







MIRROR 160 • 4.4844.1  
WASHBASIN 160 • 8.1497.1  
VANITY UNIT 135 • 4.2436.0





MIRROR 40 • 4.4841.1  
FREESTANDING TAM TAM • 8.1197.2  
FLOORSTANDING BIDET • 8.3297.1  
FLOORSTANDING WC • 8.2197.1  
SEAT & COVER • 8.9297.1





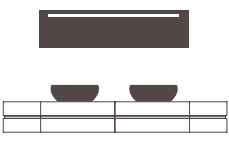

MIRROR 160 • 4.4844.1  
 WASHBASIN BOWL • 8.1897.1  
 WASHTOP 240 • 4.2462.4  
 VANITY UNIT 120 • 4.2418.0  
 VANITY UNIT 120 • 4.2417.0  
 TIDY SYSTEM FOR DRAWER • 4.9240.2 + 2 x 4.9240.1





The furniture system allows for numerous combinations of containers, mirrors, basins and counters. In the noce canaletto version, a special double coating makes the surface extremely resistant to water.

Das Möbel-System ermöglicht zahlreiche Kombinationen aus Schränken, Spiegeln, Waschtischen und Ablageboards. Bei der Version Noce Canaletto sorgt eine spezielle Zwei-Komponenten-Lackierung für eine hohe Wasserbeständigkeit der Oberflächen.

L'ensemble des éléments de rangement, des miroirs, lavabos et tablettes peut s'agencer de nombreuses façons. Pour la version en noce canaletto, une double couche de vernis spécial rend les surfaces particulièrement étanches.

Il sistema di mobili consente numerose combinazioni tra contenitori, specchi, lavabi e piani d'appoggio. Nella versione noce canaletto, una speciale doppia verniciatura rende le superfici estremamente resistenti all'acqua.

## Product Overview



1600 x 500 mm  
shelf right



1200 x 500 mm  
shelf right or left



900 x 500 mm  
shelf right or left



420 x 465 mm  
520 x 525 mm  
600 x 525 mm



520 x 530 x 850 mm



wall-hung WC  
585 x 390 mm

floorstanding WC  
585 x 390 mm

floorstanding WC  
combination  
720 x 390

one piece WC  
745 x 405 mm

urinal  
(optional lid)



freestanding bathtub  
solid surface  
1830 x 870 mm

built-in bathtub  
solid surface  
1780 x 820 mm

freestanding bathtub  
sanitary acrylic  
2030 x 1020 mm

built-in bathtub  
sanitary acrylic  
2030 x 1020 mm



vanity unit for  
countertop washbasin  
900/1200/1600x320 mm

vanity unit  
cut out central  
800 x 500 mm

vanity unit  
cut out left or right  
1200 x 500 mm

vanity unit  
cut out left and right  
1600 x 500 mm



drawer element  
without top  
400 x 540 mm  
800 x 500 mm

tall cabinet  
400 x 300 x 1700 mm

mirror  
400 x 1000 mm  
800/1200/1600 x  
400 mm

mirror cabinet  
650 x 650 mm  
800 x 650 mm

**Product Overview**



ø 530 x 900 mm  
○ ●



ø 450 mm  
●



800 x 425 mm  
●



500 x 500 mm  
520 x 520 mm  
○ ●



750 x 500 mm, semi-recessed  
750 x 520 mm  
○ ●



wall-hung bidet  
585 x 390 mm  
●



floorstanding bidet  
585 x 390 mm  
●



shelf towel holder  
632 mm



toilet paper holder



hanger



semi-recessed bathtub (left, center, right)  
sanitary acrylic  
2030 x 1020 mm



vanity unit  
cut out left or right, or left & right  
2400 x 500 mm



vanity unit for semi-recessed washbasin  
center, left or right  
800/1200 x 350 mm



washtop  
cut out left, right,  
left and right, center  
600/800/1200/  
1600/2000 x 500 mm



drawer element  
with open top  
400 x 350 mm  
400 x 500 mm  
800 x 350 mm  
800 x 500 mm

○ no taphole  
● 1 taphole



COLOURS CERAMICS  
White LCC



COLOURS FURNITURE  
Noce canaletto  
White lacquered



COLOURS BATHTUBS  
White



COLOURS SHOWER TRAYS  
White antislip



OPTIONS SHOWER ENCLOSURES  
transparent glass  
transparent glass, antiplaque

# ILBAGNOALESSI One



81497.5 ○/●  
**Countertop washbasin, shelf right**  
 Waschtisch unterbaufähig, Ablage rechts  
 Lavabo à poser sur meuble, tablette à droite  
 Lavabo consolle, mensola a destra

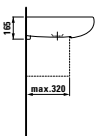
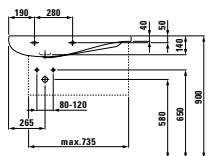
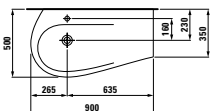

Colours: .400  
 Options: .104 .109



81497.6 ○/●  
**Countertop washbasin, shelf left**  
 Waschtisch unterbaufähig, Ablage links  
 Lavabo à poser sur meuble, tablette à gauche  
 Lavabo consolle, mensola a sinistra

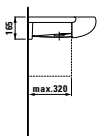
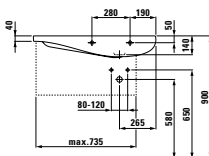
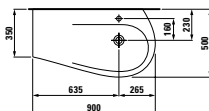

Colours: .400  
 Options: .104 .109



81497.3 ○/●  
**Countertop washbasin, shelf right**  
 Waschtisch unterbaufähig, Ablage rechts  
 Lavabo à poser sur meuble, tablette à droite  
 Lavabo consolle, mensola a destra

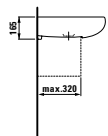
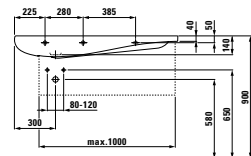
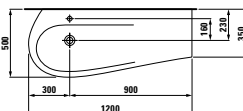

Colours: .400  
 Options: .104 .109



81497.4 ○/●  
**Countertop washbasin, shelf left**  
 Waschtisch unterbaufähig, Ablage links  
 Lavabo à poser sur meuble, tablette à gauche  
 Lavabo consolle, mensola a sinistra

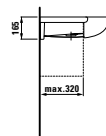
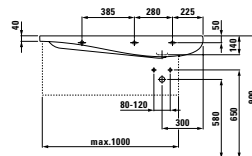
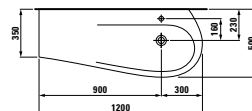

Colours: .400  
 Options: .104 .109



# ILBAGNOALESSI One



81497.1  /   
**Countertop washbasin, shelf right**  
 Waschtisch unterbaufähig, Ablage rechts  
 rechts  
 Lavabo à poser sur meuble, tablette à droite  
 Lavabo consolle, mensola a destra

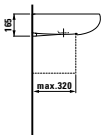
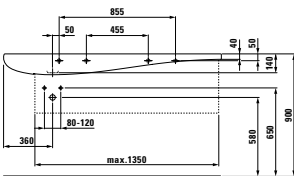
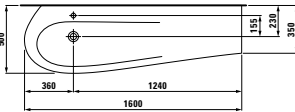

Colours: .400  
 Options: .104 .109



81897.3  /   
**Washbasin bowl, shelf left or right**  
 Aufsatz-Waschtisch, Ablage links oder rechts  
 Vasque à poser, tablette à gauche ou droite  
 Bacinella, mensola a sinistra o a destra

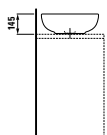
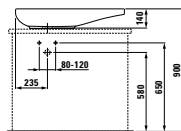
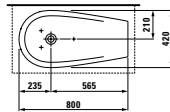

Colours: .400  
 Options: .112



81197.3  /   
**Washbasin bowl**  
 Aufsatz-Waschtisch  
 Vasque à poser  
 Bacinella

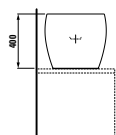
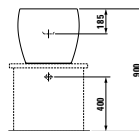
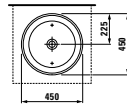

Colours: .400  
 Options: .109



81197.2  /   
**Freestanding washbasin**  
 Waschtisch freistehend  
 Lavabo indépendant  
 Lavabo a centro stanza

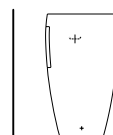
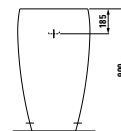
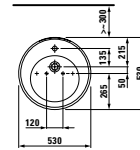

Colours: .400  
 Options: .104 .109

# ILBAGNOALESSI One



81197.1 ○/●

## Floorstanding washbasin, with wall connection

Freistehender Waschtisch mit Wandanbindung  
Lavabo au sol avec raccordement au mur  
Lavabo centro stanza con connessione a parete

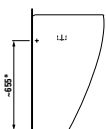
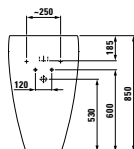
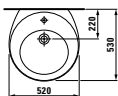

Colours: .400  
Options: .104 .109



81397.1 ○/●

## Drop-in washbasin

Einbauwaschtisch von oben  
Lavabo à encastrer par-dessous  
Lavabo da incasso soprapiano

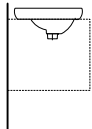
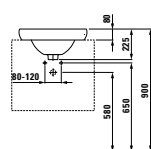
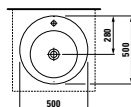

Colours: .400  
Options: .104 .109



81897.1 ○/●

## Washbasin bowl

Aufsatz-Waschtisch  
Vasque à encastrer par-dessous  
Vasque à poser  
Bacinella

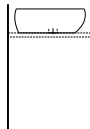
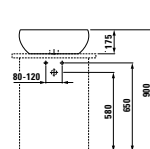
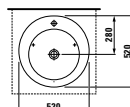

Colours: .400  
Options: .104 .109



81897.2 ○/●

## Washbasin bowl

Aufsatz-Waschtisch  
Vasque à encastrer par-dessous  
Vasque à poser  
Bacinella

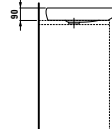
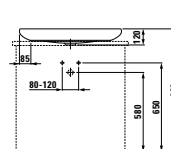
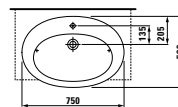

Colours: .400  
Options: .104 .109

# ILBAGNOALESSI One



81397.2 ○/●  
**Semi-recessed washbasin**  
 Halbeinbauwaschtisch  
 Lavabo à semi-encastrer  
 Lavabo semincasso

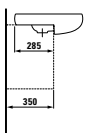
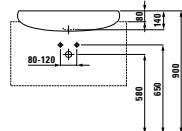
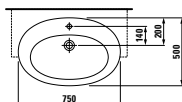

Colours: .400  
 Options: .104 .109



81597.0 ○/●  
**Small washbasin, with integrated siphon cover**  
 Handwaschbecken mit integrierter Siphonverkleidung  
 Lave-mains avec cache-siphon intégré  
 Lavamani con coprisifone integrato

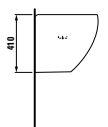
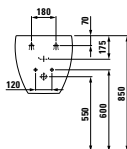
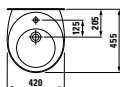

Colours: .400  
 Options: .104 .109



81097.1 ○/●  
**Washbasin, with integrated siphon cover**  
 Waschtisch mit integrierter Siphonverkleidung  
 Lavabo avec cache-siphon intégré  
 Lavabo con rivestimento integrato del sifone

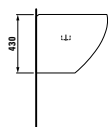
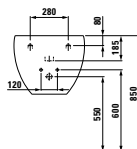
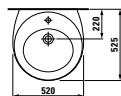

Colours: .400  
 Options: .104 .109



81097.2 ○/●  
**Washbasin, with integrated siphon cover**  
 Waschtisch mit integrierter Siphonverkleidung  
 Lavabo avec cache-siphon intégré  
 Lavabo con rivestimento integrato del sifone

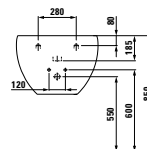
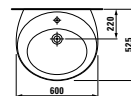

Colours: .400  
 Options: .104 .109

# ILBAGNOALESSI One



87097.0  
**Toilet paper holder**  
Papierrollenhalter  
Porte-Papier  
Portarotolo





**Colours:** .000  
**Options:** .000 .899



87097.6  
**Hanger**  
Aufhänger  
Crochet  
Portasciugamani





**Colours:** .000  
**Options:** .000\*

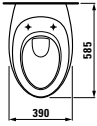
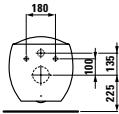
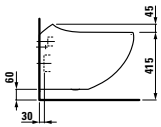

82097.6  
**Wall-hung WC, washdown**  
Wand-WC, Tiefspüler  
WC suspendu, à chasse directe  
Vaso sospeso, a cacciata

**Colours:** .400



87097.2  
**Shelf with towel holder**  
Ablage mit Handtuchschlitz  
Étagère avec porte-serviette  
Mensola con portasciugamani





**Colours:** .000  
**Options:** .000 .899

**Options for accessories:**  
Optionen für Accessoires:  
Options pour les accessoires:  
Opzioni per accessori:

**.000**  
**Screwed mounting**  
Schraubmontage  
montage à vis  
montaggio a vite

**\*Screwed and glued mounting possible**  
Schraub- und Klebmontage möglich  
montage possible à vis et avec colle  
montaggio possibile a vite e con collante

**.899**  
**Glued mounting**  
Klebmontage  
montage avec colle  
montaggio con collante



89297.1  
**Seat and cover, removable, with lowering system**  
WC-Sitz mit Deckel, abnehmbar, mit Absenkautomatik  
Siège avec abattant, amovibles, avec frein de chute  
Sedile con coperchio, rimovibile, con sistema a caduta rallentata

**Colours:** .000



# ILBAGNOALESSI One



82197.1

**Floorstanding WC, washdown, with horizontal or vertical outlet**

Stand-WC, Tiefspüler, Abgang waagrecht/senkrecht  
WC au sol à chasse directe, avec évacuation horizontale ou verticale  
Vaso a pavimento, a cacciata, scarico orizzontale/verticale

4,5L 3L

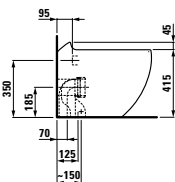
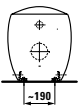
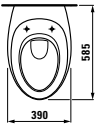

Colours: .400



82297.6

**Floorstanding WC combination, washdown, Vario outlet**

Stand-WC-Kombination, Tiefspüler, Vario Abgang  
WC au sol avec réservoir, chasse directe, évacuation Vario  
Vaso monoblocco a pavimento, a cacciata, scarico Vario

82697.1

**Cistern, Dual Flush**

Spülkasten, Dual-Flush  
Réservoir, double chasse  
Cassetta di risciacquo, Dual-Flush

4,5L 3L

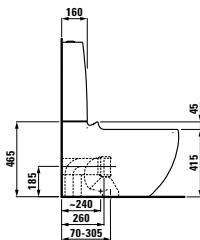
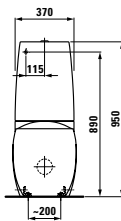
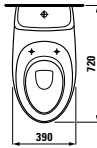

Colours: .400



82397.0

**One-piece WC, siphonic, dual flush chrome push button**

One-piece WC, siphonisch, verchromter Dual-Flush Druckknopf  
Toilette monobloc, siphonique, bouton-poussoir chromé à double-chasse  
Vaso monoblocco, sifonico, pulsante cromato dual-flush

Available from 3<sup>rd</sup> quarter 2016

Verfügbar ab 3. Quartal 2016  
Disponibile dès 3<sup>ème</sup> trimestre 2016  
Disponibile dal 3° trimestre 2016

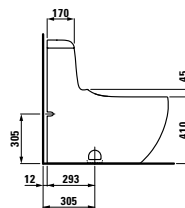
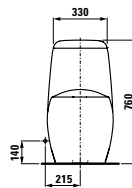
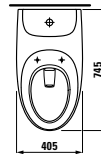

Colours: .400



82397.1

**One-piece WC, siphonic, single flush side lever**

One-piece WC, siphonisch, seitlicher Hebel für Single-Flush  
Toilette monobloc, siphonique, levier lateral pour chasse simple  
Vaso monoblocco, sifonico, leva laterale per sciacquo singolo

Available from 3<sup>rd</sup> quarter 2016

Verfügbar ab 3. Quartal 2016  
Disponibile dès 3<sup>ème</sup> trimestre 2016  
Disponibile dal 3° trimestre 2016

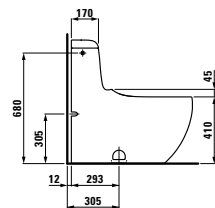
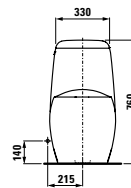
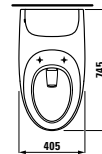

Colours: .400

# ILBAGNOALESSI One



83097.1  
**Wall-hung bidet**  
 Wandbidet  
 Bidet suspendu  
 Bidet sospeso

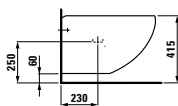
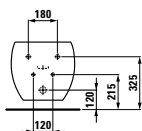
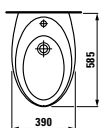

Colours: .400  
 Options: .304



83297.1  
**Floorstanding bidet**  
 Standbidet  
 Bidet au sol  
 Bidet a pavimento

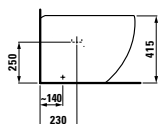
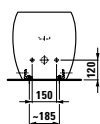
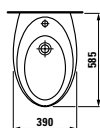

Colours: .400  
 Options: .304



84097.5  
**Siphonic urinal**  
 Absauge-Urinal  
 Urinoir à effet siphonique  
 Orinatoio ad aspirazione

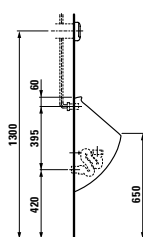
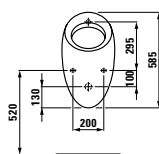

Colours: .400  
 Options: .400



84097.1  
**Siphonic urinal, with holes for cover**  
 Absauge-Urinal, mit Löchern für Deckel  
 Urinoir à effet siphonique, version pour abattant  
 Orinatoio ad aspirazione, con fori per coperchio

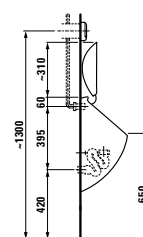
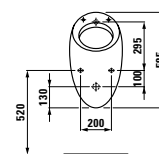

Colours: .400  
 Options: .400

# ILBAGNOALESSI One

## Options for washbasins

Optionen für Waschtische  
Options pour les lavabos  
Opzioni per lavabi

### .104 1 tap hole

- 1 Hahnloch  
1 trou pour la robinetterie  
1 foro per la rubinetteria

### .109 Without tap hole

- Ohne Hahnloch  
Non percé  
Senza foro per la rubinetteria

## Options for bidets

Optionen für Bidets  
Options pour les bidets  
Opzioni per bidet

### .304 With 1 tap hole at centre

- Mit 1 Hahnloch mittig  
Avec 1 trou pour la robinetterie  
Con 1 foro rubinetteria al centro

## Options for urinals

Optionen für Urinale  
Options pour les urinoirs  
Opzioni per orinatoi

### .400 With fly

- Mit Fliege  
Avec mouche  
Con mosca

## Colours ceramic

Farben Keramik  
Couleurs céramique  
Colori della ceramica

 **.000 White**  
Weiss  
Blanc  
Bianco

 **.400 White LCC**  
Weiss LCC  
Blanc LCC  
Bianco LCC



24597.1

**Bathtub, solid surface material, 1780x820 mm, fitted version, with frame**

Badewanne, Mineralgusswerkstoff, 1780x820 mm, Einbauversion, mit Fussgestell

Baignoire, en solid surface, 1780x820 mm, version encastrée, avec piètement

Vasca da bagno, in solid surface, 1780x820 mm, versione da incasso con base

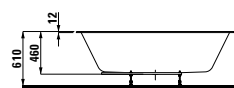
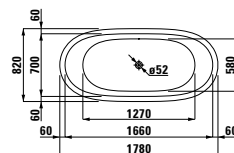

Colours: .000  
Options: .000 .605 .615 .625



24597.2

**Bathtub, solid surface material, 1830x870 mm, freestanding version, with lifting system**

Badewanne, Mineralgusswerkstoff, 1830x870 mm, freistehend, mit Hubsystem

Baignoire, en solid surface, 1830x870 mm, version indépendante, avec système élévateur

Vasca da bagno, in solid surface, 1830x870 mm, versione a centro stanza, con sistema di sollevamento della vasca

**For the installation of the bathtub a cut out in the floor is needed. Please see the technical fact sheet.**

Zur Installation der Badewanne ist ein Bodenausschnitt erforderlich. Bitte technisches Datenblatt beachten.

Une découpe dans le sol est requise pour l'installation de la baignoire.

Pour plus de détails, merci de consulter la fiche technique.

Per l'installazione della vasca da bagno prevedere scasso a pavimento. Consultare le specifiche tecniche per maggiori informazioni.

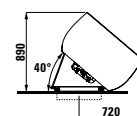
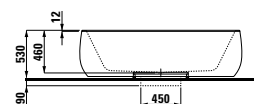
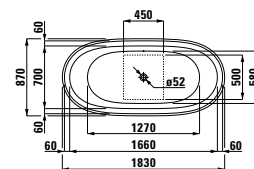

Colours: .000  
Options: .000 .605 .615 .625

## Colours bathtubs

24597.1 and 24597.2

Farben Badewannen

24597.1 und 24597.2

Couleurs baignoires

24597.1 et 24597.2

Colori delle vasche da bagno

24597.1 e 24597.2

 **.000 White**  
Weiss  
Blanc  
Bianco

## Options bathtubs

24597.1 and 24597.2

Optionen Badewannen

24597.1 und 24597.2

Options pour baignoires

24597.1 et 24597.2

Versioni delle vasche da bagno

24597.1 e 24597.2

**.000**

**Without whirl system**

Ohne Whirlsystem

Sans système balnéo

Senza sistema idromassaggio

**.605 / .615 / .625**

**Whirl system with sensor**

Whirlsystem mit Sensorsteuerung

Système balnéo avec capteur

Sistemi idromassaggio con sensore

**Number of air holes**

**90**

Anzahl Luftlöcher

Nombre de trous d'aération

Numero di fori di aerazione

# ILBAGNOALESSI One



**24397.0**  
**Bathtub, sanitary acrylic, 2030x1020 mm, fitted version, with frame, also available with whirl system**  
 Badewanne, Sanitäracryl, 2030x1020 mm, Einbauversion, mit Fußgestell, auch mit Whirlsystem erhältlich  
 Baignoire, acrylique sanitaire, 2030x1020 mm, version encastrée, sans tablier, avec piètement, également disponible avec système balnéo  
 Vasca da bagno, acrilico sanitario, 2030x1020 mm, versione da incasso, con base, disponibile anche con sistema idromassaggio

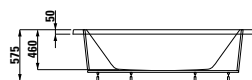
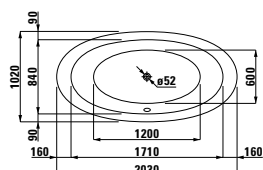

**Colours:** .000  
**Options:** .000 .675 .695 .056 .057



**24197.0**  
**Bathtub, sanitary acrylic, 2030x1020 mm, freestanding version, with panel, also available with whirl system**  
 Badewanne, Sanitäracryl, 2030x1020 mm, freistehend, mit einteiliger Schürze, auch mit Whirlsystem erhältlich  
 Baignoire, acrylique sanitaire, 2030x1020 mm, version indépendante, avec tablier, également disponible avec système balnéo  
 Vasca da bagno, acrilico sanitario, 2030x1020 mm, versione a centro stanza, con pannello di rivestimento monopezzo, disponibile anche con sistema idromassaggio

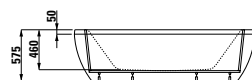
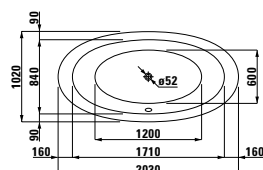

**Colours:** .000  
**Options:** .000 .675 .695 .056 .057



**24497.0**  
**Bathtub, sanitary acrylic, 2030x1020 mm, semi-recessed version, with half panel, also available with whirl system**  
 Badewanne, Sanitäracryl, 2030x1020 mm, Halbeinbauversion, mit Frontschürze, auch mit Whirlsystem erhältlich  
 Baignoire, acrylique sanitaire, 2030x1020 mm, version semi-encastrée, avec tablier frontal, également disponible avec système balnéo  
 Vasca da bagno, acrilico sanitario, 2030x1020 mm, versione a semincasso, con semipannello di rivestimento, disponibile anche con sistema idromassaggio

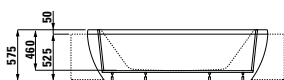
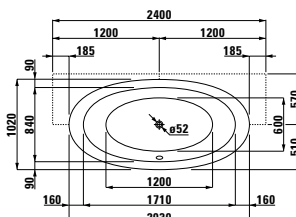

**Colours:** .000  
**Options:** .000 .675 .695 .056 .057

## Colours bathtubs

**24197.0, 24397.0 and 24497.0**  
 Farben Badewannen  
 24197.0, 24397.0 und 24497.0  
 Couleurs baignoires  
 24197.0, 24397.0 et 24497.0  
 Colori delle vasche da bagno  
 24197.0, 24397.0 e 24497.0



## Options bathtubs

**24197.0, 24397.0 and 24397.0**  
 Optionen Badewannen  
 24197.0, 24397.0 und 24397.0  
 Options pour baignoires  
 24197.0, 24397.0 et 24397.0  
 Versioni delle vasche da bagno  
 24197.0, 24397.0 e 24397.0

**.000**  
**Without whirl system**  
 Ohne Whirlsystem  
 Sans système balnéo  
 Senza sistema idromassaggio

**.675 / .695**  
**Whirl system with sensor**  
 Whirlsystem mit Sensorsteuerung  
 Système balnéo avec capteur  
 Sistemi idromassaggio con sensore

**Number of air holes 88**  
 Anzahl Luftlöcher  
 Nombre de trous d'aération  
 Numero di fori di aerazione

**Number of micro-nozzles 8**  
 Anzahl Mikrodüsen  
 Nombre de tuyères  
 Numero di microbocchette

**Number of side nozzles 6**  
 Anzahl Seitendüsen  
 Nombre de tuyères latérales  
 Numero di bocchette laterali



# ILBAGNOALESSI One

## Options bathtubs with whirlsystem

Ausführungen Badewannen mit Whirlsystem

Exécutions des baignoires avec balnéo

Versioni delle vasche con sistema idromassaggio

## .000 Without whirlsystem

Ohne Whirlsystem

Sans balnéo

Senza sistema idromassaggio

## Whirlsystems with sensor

Elektronische Sensorsteuerung

Commande électronique avec détecteur

Sistemi idromassaggio con sensore

	<b>Air massage</b> /Luftmassage/Aéromassage/ Idromassaggio a getto d'aria	<b>Hydromassage</b> /Wassermassage/ Hydromassage/Idromassaggio aria/acqua	<b>Disinfection</b> /Desinfektion/ Désinfection/Igienizzazione	<b>Heating</b> /Heizung/ Chauffage/Riscaldatore	<b>LED light</b> /LED-Licht/ Eclairage LED/Luce a LED	<b>Steam</b> /Dampf/Vapeur/Umidità	<b>Display</b> /Display/Affichage/Display	<b>Music</b> /Musik/Musique/Musica
Option .605	x							
Option .615					x			
Option .625	x				x			
Option .635		x						
Option .645	x	x						
Option .675	x	x			x			
Option .695	x	x	x		x			

# ILBAGNOALESSI One



45851.1

**Bathtub panel, for semi-recessed bathtub 24497.0, overall length 2400 mm**

Badewannenpanel, für Halbeinbau-Badewanne 24497.0, gesamt 2400 mm

Tablier en bois, pour baignoire semi-encastrée 24497.0, longueur totale 2400 mm

Pannello per vasca da bagno a semincasso 24497.0, totale 2400 mm

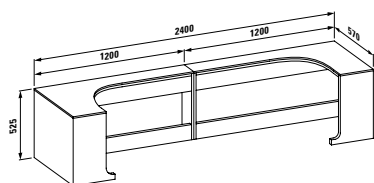

45851.4

**Bathtub panel, for semi-recessed bathtub 24497.0, storage left and right, overall length 4000 mm**

Badewannenpanel, für Halbeinbau-Badewanne 24497.0, Ablage links und rechts, gesamt 4000 mm

Tablier en bois, pour baignoire semi-encastrée 24497.0, rangement à gauche et à droite, longueur totale 4000 mm

Pannello per vasca da bagno a semincasso 24497.0, mensola a sinistra e a destra, totale 4000 mm

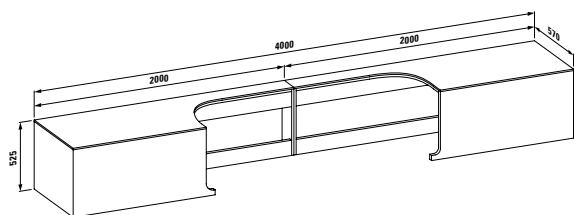

Colours: .630 .631



45851.2

**Bathtub panel, for semi-recessed bathtub 24497.0, storage left, overall length 3200 mm**

Badewannenpanel für Halbeinbau-Badewanne 24497.0, Ablage links, gesamt 3200 mm

Tablier en bois, pour baignoire semi-encastrée 24497.0, rangement à gauche, longueur totale 3200 mm

Pannello per vasca da bagno a semincasso 24497.0, mensola a sinistra, totale 3200 mm

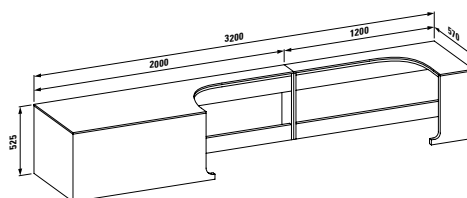

45851.3

**Bathtub panel, for semi-recessed bathtub 24497.0, storage right, overall length 3200 mm**

Badewannenpanel für Halbeinbau-Badewanne 24497.0, Ablage rechts, gesamt 3200 mm

Tablier en bois, pour baignoire semi-encastrée 24497.0, rangement à droite, longueur totale 3200 mm

Pannello per vasca da bagno a semincasso 24497.0, mensola a destra, totale 3200 mm

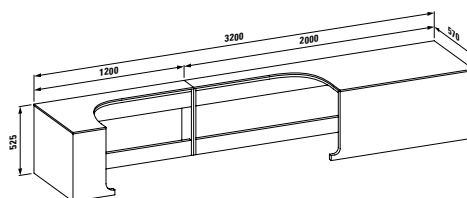

Colours: .630 .631

# ILBAGNOALESSI One

## Colours furniture

Farben Möbel

Couleurs meubles

Colori dei mobili



### **.631 White lacquered**

Weiss lackiert











Blanc laqué

Bianco laccato



### **.630 Noce canaletto**







# Possible washbasin/washtop combinations

Washtop Waschtischplatte Plan de toilette Piano d'appoggio	800			1200			
Optional drawer elements Optionale Schubladenelemente Éléments tiroirs en option Elementi a cassetti opzionali	 42301.3	 42311.3	 42311.4	 42311.1	 42311.2	 42321.3	
<b>Washbasin</b> Waschtisch Lavabo Lavabo  <b>ILBAGNOALESSI ONE</b>   81197.3 Ø 450 mm	●	●	●	●	●	●	
 81897.1 Ø 520 mm	●	●	●	● /R <b>Drawer element</b> Schubladenelement Element tiroir Elementi a cassetti 42440.2	● /L <b>Drawer element</b> Schubladenelement Element tiroir Elementi a cassetti 42440.2	● /LR <b>Drawer element</b> Schubladenelement Element tiroir Elementi a cassetti 42440.2	
 81397.1 Ø 500 mm	●	●	●	● /R <b>Drawer element</b> Schubladenelement Element tiroir Elementi a cassetti 42440.2	● /L <b>Drawer element</b> Schubladenelement Element tiroir Elementi a cassetti 42440.2	● /LR <b>Drawer element</b> Schubladenelement Element tiroir Elementi a cassetti 42440.2	
 81897.2 750x520 mm	●	●		● /R <b>Drawer element</b> Schubladenelement Element tiroir Elementi a cassetti 42440.2	● /L <b>Drawer element</b> Schubladenelement Element tiroir Elementi a cassetti 42440.2	● /LR <b>Drawer element</b> Schubladenelement Element tiroir Elementi a cassetti 42440.2	
 81897.3 800x420 mm	●	●		● /R <b>Drawer element</b> Schubladenelement Element tiroir Elementi a cassetti 42440.2	● /L <b>Drawer element</b> Schubladenelement Element tiroir Elementi a cassetti 42440.2	●	

● **can be combined with a washtop**  
kann mit einer Waschtischplatte kombiniert werden  
peut être combiné avec un plan de toilette  
componibile con un piano d'appoggio

M **can be combined with a central drawer element**  
kann mit einem Schubladenelement mittig kombiniert werden  
peut être combiné avec un élément tiroirs au milieu  
componibile con un elemento a cassetti centrale



1600				2000			
							
42321.4	42321.1	42321.2	42325.3	42325.4	42325.1	42325.2	
●	●	●	●	●	●	●	
●	● /R <b>Drawer element</b> Schubladenelement Element tiroir Elementi a cassetti 42440.2, 42442.2	● /L <b>Drawer element</b> Schubladenelement Element tiroir Elementi a cassetti 42440.2, 42442.2	● /LR <b>Drawer element</b> Schubladenelement Element tiroir Elementi a cassetti 42440.2	● /M <b>Drawer element</b> Schubladenelement Element tiroir Elementi a cassetti 42440.2	● /R <b>Drawer element</b> Schubladenelement Element tiroir Elementi a cassetti 42440.2, 42442.2	● /L <b>Drawer element</b> Schubladenelement Element tiroir Elementi a cassetti 42440.2, 42442.2	
●	● /R <b>Drawer element</b> Schubladenelement Element tiroir Elementi a cassetti 42440.2, 42442.2	● /L <b>Drawer element</b> Schubladenelement Element tiroir Elementi a cassetti 42440.2, 42442.2	● /LR <b>Drawer element</b> Schubladenelement Element tiroir Elementi a cassetti 42440.2	● /M <b>Drawer element</b> Schubladenelement Element tiroir Elementi a cassetti 42440.2	● /R <b>Drawer element</b> Schubladenelement Element tiroir Elementi a cassetti 42440.2, 42442.2	● /L <b>drawer element</b> Schubladenelement Element tiroir Elementi a cassetti 42440.2, 42442.2	
●	● /R <b>Drawer element</b> Schubladenelement Element tiroir Elementi a cassetti 42440.2, 42442.2	● /L <b>Drawer element</b> Schubladenelement Element tiroir Elementi a cassetti 42440.2, 42442.2	● /LR <b>Drawer element</b> Schubladenelement Element tiroir Elementi a cassetti 42440.2	● /M <b>Drawer element</b> Schubladenelement Element tiroir Elementi a cassetti 42440.2	● /R <b>Drawer element</b> Schubladenelement Element tiroir Elementi a cassetti 42440.2, 42442.2	● /L <b>Drawer element</b> Schubladenelement Element tiroir Elementi a cassetti 42440.2, 42442.2	
	● /R <b>Drawer element</b> Schubladenelement Element tiroir Elementi a cassetti 42440.2, 42442.2	● /L <b>Drawer element</b> Schubladenelement Element tiroir Elementi a cassetti 42440.2, 42442.2	● /LR <b>Drawer element</b> Schubladenelement Element tiroir Elementi a cassetti 42440.2	● <b>Drawer element</b> Schubladenelement Element tiroir Elementi a cassetti 42440.2	● /R <b>Drawer element</b> Schubladenelement Element tiroir Elementi a cassetti 42440.2, 42442.2	● /L <b>Drawer element</b> Schubladenelement Element tiroir Elementi a cassetti 42440.2, 42442.2	

L **can be combined with one drawer element on the left**  
kann mit einem Schubladenelement links kombiniert werden  
peut être combiné avec un élément tiroirs à gauche  
componibile con un elemento a cassetti a sinistra

R **can be combined with one drawer element on the right**  
kann mit einem Schubladenelement rechts kombiniert werden  
peut être combiné avec un élément tiroirs à droite  
componibile con un elemento a cassetti a destra

# ILBAGNOALESSI One



## Washtop, 800 mm, including mounting brackets

Waschtischplatte 800 mm, inkl. Befestigungselemente  
Plan de toilette, 800 mm, avec jeu de fixations inclus  
Piano d'appoggio 800 mm, con elemento di fissaggio

**42300.0**  
**Without cut-out**  
Ohne Ausschnitt  
Sans découpe  
Senza taglio

**42301.3**  
**With central cut-out**  
Mit Ausschnitt in der Mitte  
Avec découpe centrale  
Con taglio al centro

### Please state washbasin number in the order form.

Bitte bei der Bestellung die Artikelnummer des Waschtisches vermerken.

Veillez indiquer le numéro de référence du lavabo lors de la commande.

Al momento dell'ordine annotare il numero di articolo del lavabo.

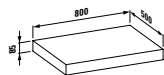

Colours: .630 .631



## Washtop, 1200 mm, including mounting brackets

Waschtischplatte, 1200 mm, inkl. Befestigungselemente  
Plan de toilette, 1200 mm, avec jeu de fixations inclus  
Piano d'appoggio, 1200 mm, con elemento di fissaggio

**42310.0**  
**Without cut-out**  
Ohne Ausschnitt  
Sans découpe  
Senza taglio

**42311.1**  
**With cut-out left**  
Mit Ausschnitt links  
Avec découpe à gauche  
Con taglio a sinistra

**42311.2**  
**With cut-out right**  
Mit Ausschnitt rechts  
Avec découpe à droite  
Con taglio a destra

**42311.3**  
**With central cut-out**  
Mit Ausschnitt in der Mitte  
Avec découpe centrale  
Con taglio al centro

**42311.4**  
**With cut-out left and right**  
Mit Ausschnitt links und rechts  
Avec découpe à gauche et à droite  
Con taglio a sinistra et a destra

### Please state washbasin number in the order form.

Bitte bei der Bestellung die Artikelnummer des Waschtisches vermerken.

Veillez indiquer le numéro de référence du lavabo lors de la commande.

Al momento dell'ordine annotare il numero di articolo del lavabo.

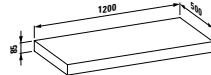

Colours: .630 .631



## Washtop, 1600 mm, including mounting brackets

Waschtischplatte, 1600 mm, inkl. Befestigungselemente  
Plan de toilette, 1600 mm, avec jeu de fixations inclus  
Piano d'appoggio, 1600 mm, con elemento di fissaggio

**42320.0**  
**Without cut-out**  
Ohne Ausschnitt  
Sans découpe  
Senza taglio

**42321.1**  
**With cut-out left**  
Mit Ausschnitt links  
Avec découpe à gauche  
Con taglio a sinistra

**42321.2**  
**With cut-out right**  
Mit Ausschnitt rechts  
Avec découpe à droite  
Con taglio a destra

**42321.3**  
**With central cut-out**  
Mit Ausschnitt in der Mitte  
Avec découpe centrale  
Con taglio al centro

**42321.4**  
**With cut-out left and right**  
Mit Ausschnitt links und rechts  
Avec découpe à gauche et à droite  
Con taglio a sinistra et a destra

### Please state washbasin number in the order form.

Bitte bei der Bestellung die Artikelnummer des Waschtisches vermerken.

Veillez indiquer le numéro de référence du lavabo lors de la commande.

Al momento dell'ordine annotare il numero di articolo del lavabo.

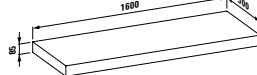

Colours: .630 .631



## Washtop, 2000 mm, including mounting brackets

Waschtischplatte, 2000 mm, inkl. Befestigungselemente  
Plan de toilette, 2000 mm, avec jeu de fixations inclus  
Piano d'appoggio, 2000 mm, con elemento di fissaggio

**42325.0**  
**Without cut-out**  
Ohne Ausschnitt  
Sans découpe  
Senza taglio

**42325.1**  
**With cut-out left**  
Mit Ausschnitt links  
Avec découpe à gauche  
Con taglio a sinistra

**42325.2**  
**With cut-out right**  
Mit Ausschnitt rechts  
Avec découpe à droite  
Con taglio a destra

**42325.3**  
**With central cut-out**  
Mit Ausschnitt in der Mitte  
Avec découpe centrale  
Con taglio al centro

**42325.4**  
**With cut-out left and right**  
Mit Ausschnitt links und rechts  
Avec découpe à gauche et à droite  
Con taglio a sinistra et a destra

### Please state washbasin number in the order form.

Bitte bei der Bestellung die Artikelnummer des Waschtisches vermerken.

Veillez indiquer le numéro de référence du lavabo lors de la commande.

Al momento dell'ordine annotare il numero di articolo del lavabo.



Colours: .630 .631

# ILBAGNOALESSI One



42440.2

**Drawer element 400 mm, for mounting under washtop, with 2 drawers, with soft close mechanism**

Schubladenelement 400 mm, für Montage unter der Waschtischplatte, mit 2 Schubladen, mit Softclose  
 Élément tiroir 400 mm, pour montage sous le plan de toilette, avec 2 tiroirs, avec mécanisme soft close  
 Elemento a cassetto 400 mm, per montaggio sotto il piano di appoggio, con due cassetti, con Softclose

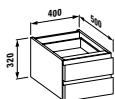

**Colours:** .630 .631



42442.2

**Drawer element 800 mm, for mounting under washtop, with 2 drawers, with soft close mechanism**

Schubladenelement 800 mm, für Montage unter der Waschtischplatte, mit 2 Schubladen, mit Softclose  
 Élément tiroir 800 mm, pour montage sous le plan de toilette, avec 2 tiroirs, avec mécanisme soft close  
 Elemento a cassetto 800 mm, per montaggio sotto il piano di appoggio, con due cassetti, con Softclose



**Colours:** .630 .631



**Drawer element, with 12 mm top, for mounting on washtop, with 2 drawers, with soft close mechanism**

Schubladenelement, mit 12 mm Platte, für Montage auf der Waschtischplatte, mit 2 Schubladen, mit Softclose  
 Élément tiroir, avec plaque de 12 mm, pour montage sur le plan de toilette, avec 2 tiroirs, avec mécanisme soft close  
 Elemento a cassetto, con piano di 12 mm, per montaggio sopra il piano di appoggio, con due cassetti, con Softclose

	A	B
43011.1	400	500
43012.1	400	350
43021.1	800	500
43022.1	800	350

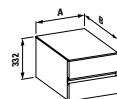

**Colours:** .630 .631

# ILBAGNOALESSI One



42445.0

**Vanity unit for washbasin 81497.6, with soft close mechanism, with 2 drawers**

Waschtischunterbau für Waschtisch 81497.6, mit Softclose, mit 2 Schubladen

Meuble sous lavabo 81497.6, avec mécanisme soft close, avec 2 tiroirs  
Base sottolavabo per lavabo 81497.6, con Softclose, con 2 cassette

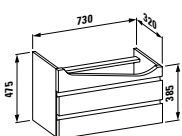

Colours: .630 .631



42447.0

**Vanity unit for washbasin 81497.5, with soft close mechanism, with 2 drawers**

Waschtischunterbau für Waschtisch 81497.5, mit Softclose, mit 2 Schubladen

Meuble sous lavabo 81497.6, avec mécanisme soft close, avec 2 tiroirs  
Base sottolavabo per lavabo 81497.6, con Softclose, con 2 cassette

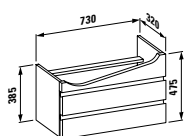

Colours: .630 .631



42450.0

**Vanity unit for washbasin 81497.4, with soft close mechanism, with 2 drawers**

Waschtischunterbau für Waschtisch 81497.4, mit Softclose, mit 2 Schubladen

Meuble sous lavabo 81497.4, avec mécanisme soft close, avec 2 tiroirs  
Base sottolavabo per lavabo 81497.4, con Softclose, con 2 cassette

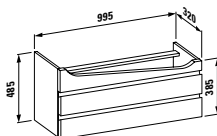

Colours: .630 .631



42452.0

**Vanity unit for washbasin 81497.3, with soft close mechanism, with 2 drawers**

Waschtischunterbau für Waschtisch 81497.3, mit Softclose, mit 2 Schubladen

Meuble sous lavabo 81497.3, avec mécanisme soft close, avec 2 tiroirs  
Base sottolavabo per lavabo 81497.3, con Softclose, con 2 cassette

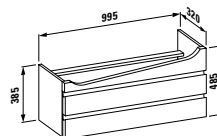

Colours: .630 .631



# ILBAGNOALESSI One



42436.0

**Vanity unit for washbasin 81497.1, with soft close mechanism, with 2 drawers**

Waschtischunterbau für Waschtisch 81497.1, mit Softclose, mit 2 Schubladen

Meuble sous lavabo 81497.1, avec mécanisme soft close, avec 2 tiroirs

Base sottolavabo per lavabo 81497.1, con Softclose, con 2 cassetti

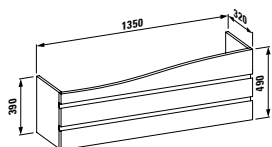

Colours: .630 .631



42405.3

**Vanity unit for washbasin 81397.2, central cut-out, with space-saving siphon and soft close mechanism, with 1 drawer**

Waschtischunterbau, für Waschtisch 81397.2, Ausschnitt in der Mitte, mit platzsparendem Siphon und Softclose, mit 1 Schublade

Meuble sous lavabo, pour lavabo 81397.2, découpe centrale, avec siphon gain de place et mécanisme soft close, avec 1 tiroir

Base sottolavabo, per lavabo 81397.2, taglio al centro, con sifone salvaspazio e Softclose, con 1 cassetto

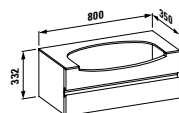

Colours: .630 .631



42415.1

**Vanity unit for washbasin 81397.2, cut-out left, with space-saving siphon and soft close mechanism, with 3 drawers**

Waschtischunterbau, für Waschtisch 81397.2, Ausschnitt links, mit platzsparendem Siphon und Softclose, mit 3 Schubladen

Meuble sous lavabo, pour lavabo 81397.2, découpe à gauche, avec siphon gain de place et mécanisme soft close, avec 3 tiroirs

Base sottolavabo, per lavabo 81397.2, taglio a sinistra, con sifone salvaspazio e Softclose, con 3 cassetti

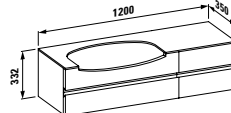

Colours: .630 .631



42415.2

**Vanity unit for washbasin 81397.2, cut-out right, with space-saving siphon and soft close mechanism, with 3 drawers**

Waschtischunterbau, für Waschtisch 81397.2, Ausschnitt rechts, mit platzsparendem Siphon und Softclose, mit 3 Schubladen

Meuble sous lavabo, pour lavabo 81397.2, découpe à droite, avec siphon gain de place et mécanisme soft close, avec 3 tiroirs

Base sottolavabo, per lavabo 81397.2, taglio a destra, con sifone salvaspazio e Softclose, con 3 cassetti

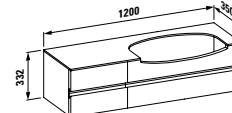

Colours: .630 .631

# ILBAGNOALESSI One



**Vanity unit, with central cut-out, with space-saving siphon and soft close mechanism**

Waschtischunterbau, mit Ausschnitt in der Mitte, mit platzsparendem Siphon und Softclose

Meuble sous lavabo, avec découpe centrale, avec siphon gain de place et mécanisme soft close

Base sottolavabo, con taglio al centro, con sifone salvaspazio e Softclose

**42402.3**

**For 81897.1, with 2 drawers**

Für 81897.1, mit 2 Schubladen

Pour 81897.1, avec 2 tiroirs

Per 81897.1, con 2 cassetti

**42403.3**

**For 81897.2, with 2 drawers**

Für 81897.2, mit 2 Schubladen

Pour 81897.2, avec 2 tiroirs

Per 81897.2, con 2 cassetti

**42404.3**

**For 81397.1, with 1 drawer**

Für 81397.1, mit 1 Schublade

Pour 81397.1, avec 1 tiroir

Per 81397.1, con 1 cassetto

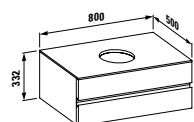

Colours: .630 .631



**Vanity unit, with cut-out left, with space-saving siphon and soft close mechanism**

Waschtischunterbau, mit Ausschnitt links, mit platzsparendem Siphon und Softclose

Meuble sous lavabo, avec découpe à gauche, avec siphon gain de place et mécanisme soft close

Base sottolavabo, con taglio a sinistra, con sifone salvaspazio e Softclose

**42412.1**

**For 81897.1, with 4 drawers**

Für 81897.1, mit 4 Schubladen

Pour 81897.1, avec 4 tiroirs

Per 81897.1, con 4 cassetti

**42413.1**

**For 81897.2, with 4 drawers**

Für 81897.2, mit 4 Schubladen

Pour 81897.2, avec 4 tiroirs

Per 81897.2, con 4 cassetti

**42414.1**

**For 81397.1, with 3 drawers**

Für 81397.1, mit 3 Schubladen

Pour 81397.1, avec 3 tiroirs

Per 81397.1, con 3 cassetti

**42416.1**

**For 81897.3, with 4 drawers**

Für 81897.3, mit 4 Schubladen

Pour 81897.3, avec 4 tiroirs

Per lavabo 81897.3, con 4 cassetti

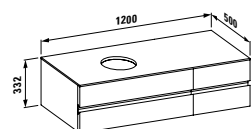

Colours: .630 .631



**Vanity unit, with cut-out right, with space-saving siphon and soft close mechanism**

Waschtischunterbau, mit Ausschnitt rechts, mit platzsparendem Siphon und Softclose

Meuble sous lavabo, avec découpe à droite, avec siphon gain de place et mécanisme soft close

Base sottolavabo, con taglio a destra, con sifone salvaspazio e Softclose

**42412.2**

**For 81897.1, with 4 drawers**

Für 81897.1, mit 4 Schubladen

Pour 81897.1, avec 4 tiroirs

Per 81897.1, con 4 cassetti

**42413.2**

**For 81897.2, with 4 drawers**

Für 81897.2, mit 4 Schubladen

Pour 81897.2, avec 4 tiroirs

Per 81897.2, con 4 cassetti

**42414.2**

**For 81397.1, with 3 drawers**

Für 81397.1, mit 3 Schubladen

Pour 81397.1, avec 3 tiroirs

Per 81397.1, con 3 cassetti

**42416.2**

**For 81897.3, with 4 drawers**

Für 81897.3, mit 4 Schubladen

Pour 81897.3, avec 4 tiroirs

Per lavabo 81897.3, con 4 cassetti

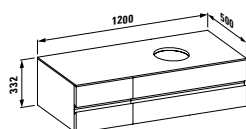

Colours: .630 .631



**42426.1  
Vanity unit for washbasin 81897.3, with cut-out left, with 4 drawers, with space-saving siphon and soft close mechanism**

Waschtischunterbau, für Waschtisch 81897.3, mit Ausschnitt links, mit 4 Schubladen, mit platzsparendem Siphon und Softclose

Meuble sous lavabo, pour lavabo 81897.3, avec découpe à gauche, avec 4 tiroirs, avec siphon gain de place et mécanisme soft close

Base sottolavabo, per lavabo 81897.3, con taglio a sinistra, con 4 cassetti, con sifone salvaspazio e Softclose

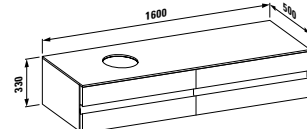

Colours: .630 .631

# ILBAGNOALESSI One



**42426.2**  
**Vanity unit for washbasin 81897.3, with cut-out right, with 4 drawers, with space-saving siphon and soft close mechanism**

Waschtischunterbau, für Waschtisch 81897.3, mit Ausschnitt rechts, mit 4 Schubladen, mit platzsparendem Siphon und Softclose

Meuble sous lavabo, pour lavabo 81897.3, avec découpe à droite, avec 4 tiroirs, avec siphon gain de place et mécanisme soft close

Base sottolavabo, per lavabo 81897.3, con taglio a destra, con 4 cassetti, con sifone salvaspazio e Softclose



**Vanity unit, with cut-out left and right, with space-saving siphon and soft close mechanism**

Waschtischunterbau, mit Ausschnitt links und rechts, mit platzsparendem Siphon und Softclose

Meuble sous lavabo, avec découpe à droite et à gauche, avec siphon gain de place et mécanisme soft close

Base sottolavabo, con taglio a sinistra e a destra, sifone salvaspazio e Softclose

**42422.4**  
**For 81897.1, with 4 drawers**

Für 81897.1, mit 4 Schubladen

Pour 81897.1, avec 4 tiroirs

Per 81897.1, con 4 cassetti

**42424.4**  
**For 81397.1, with 2 drawers**

Für 81397.1, mit 2 Schubladen

Pour 81397.1, avec 2 tiroirs

Per 81397.1, con 2 cassetti

**49240.2**  
**Drawer organizer**

Ordnungssystem für Schublade

Système de rangement pour tiroir

Sistema di messa in ordine per cassetto

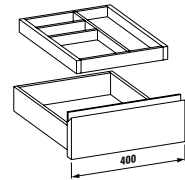
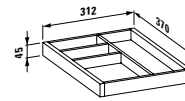

**49240.1**  
**Drawer organizer for small drawer**

Ordnungssystem für kleine Schublade

Schlublade

Système de rangement pour petit tiroir

tiroir

Sistema di messa in ordine per cassetto piccolo

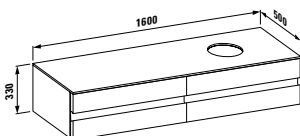
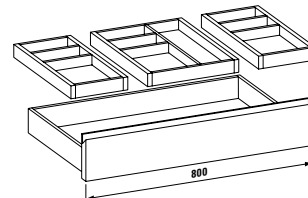
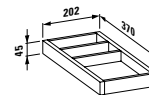

Colours: .630 .631

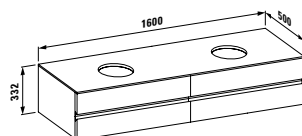

Colours: .630 .631

**Not available for:**

Nicht erhältlich für:

Non disponible pour:

Non disponibile per:

43012.1 / 43022.1 / 42405.3 / 42415.1 /

42415.2 / 42436.0

Colours: .630 .631

# ILBAGNOALESSI One



## Top for vanity unit

Deckplatte für Waschtischunterbau  
Panneau pour meuble sous lavabo  
Piano di appoggio per base de sottolavabo

42460.2

### With cut-out left, for two vanity units with large drawers left

Mit Ausschnitt links, für zwei Unterbauten mit breiten Schubladen links  
Avec découpe à gauche, pour deux meubles sous lavabo avec tiroirs larges à gauche  
Con taglio a sinistra, per due base de sottolavabo con cassetti largi a sinistra

42460.3

### With cut-out right, for two vanity units with large drawers left

Mit Ausschnitt rechts, für zwei Unterbauten mit breiten Schubladen links  
Avec découpe à droite, pour deux meubles sous lavabo avec tiroirs larges à gauche  
Con taglio a destra, per due base de sottolavabo con cassetti largi a sinistra

42460.4

### With cut-out left and right, for two vanity units with large drawers left

Mit Ausschnitt rechts, für zwei Unterbauten mit breiten Schubladen links  
Avec découpe à droite, pour deux meubles sous lavabo avec tiroirs larges à gauche  
Con taglio a sinistra e a destra, per due base de sottolavabo con cassetti largi a sinistra

## Please state washbasin number in the order form.

Bitte bei der Bestellung die Artikelnummer des Waschtisches vermerken.  
Veuillez indiquer le numéro de référence du lavabo lors de la commande.  
Al momento dell'ordine annotare il numero di articolo del lavabo.

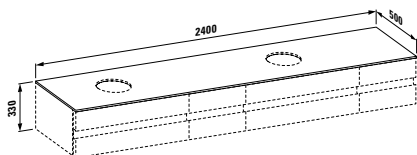

42417.0

### Vanity unit, without top, with 4 drawers, with large drawers left, with space-saving siphon and soft close mechanism

Waschtischunterbau, ohne Deckplatte, mit breiten Schubladen links, mit 4 Schubladen, mit platzsparendem Siphon und Softclose  
Meuble sous lavabo, sans plaque de couverture, avec 4 tiroirs, avec tiroirs larges à gauche, avec siphon gain de place et mécanisme soft close  
Base sottolavabo, senza piano di appoggio, con 4 cassetti, con cassetti grandi a sinistra, con sifone salvaspazio e Softclose

42417.0

### Vanity unit, without top, with 4 drawers, with large drawers left, with space-saving siphon and soft close mechanism

Waschtischunterbau, ohne Deckplatte, mit breiten Schubladen links, mit 4 Schubladen, mit platzsparendem Siphon und Softclose  
Meuble sous lavabo, sans plaque de couverture, avec 4 tiroirs, avec tiroirs larges à gauche, avec siphon gain de place et mécanisme soft close  
Base sottolavabo, senza piano di appoggio, con 4 cassetti, con cassetti grandi a sinistra, con sifone salvaspazio e Softclose

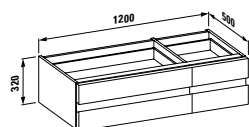
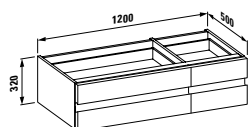

Colours: .630 .631



## Top for vanity unit

Deckplatte für Waschtischunterbau  
Panneau pour meuble sous lavabo  
Piano di appoggio per base de sottolavabo

42461.2

### With cut-out left, for two vanity units with large drawers right

Mit Ausschnitt links, für zwei Unterbauten mit breiten Schubladen rechts  
Avec découpe à gauche, pour deux meubles sous lavabo avec tiroirs larges à droite  
Con taglio a sinistra, per due base de sottolavabo con cassetti largi a destra

42461.3

### With cut-out right, for two vanity units with large drawers right

Mit Ausschnitt rechts, für zwei Unterbauten mit breiten Schubladen rechts  
Avec découpe à droite, pour deux meubles sous lavabo avec tiroirs larges à droite  
Con taglio a destra, per due base de sottolavabo con cassetti largi a destra

42461.4

### With cut-out left and right, for two vanity units with large drawers right

Mit Ausschnitt rechts, für zwei Unterbauten mit breiten Schubladen rechts  
Avec découpe à droite, pour deux meubles sous lavabo avec tiroirs larges à droite  
Con taglio a sinistra e a destra, per due base de sottolavabo con cassetti largi a destra

## Please state washbasin number in the order form.

Bitte bei der Bestellung die Artikelnummer des Waschtisches vermerken.  
Veuillez indiquer le numéro de référence du lavabo lors de la commande.  
Al momento dell'ordine annotare il numero di articolo del lavabo.

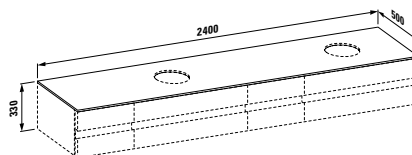

42418.0

### Vanity unit, without top, with 4 drawers, with large drawers right, with space-saving siphon and soft close mechanism

Waschtischunterbau, ohne Deckplatte, mit breiten Schubladen rechts, mit 4 Schubladen, mit platzsparendem Siphon und Softclose  
Meuble sous lavabo, sans plaque de couverture, avec 4 tiroirs, avec tiroirs larges à droite, avec siphon gain de place et mécanisme soft close  
Base sottolavabo, senza piano di appoggio, con 4 cassetti, con cassetti grandi a destra, con sifone salvaspazio e Softclose

42418.0

### Vanity unit, without top, with 4 drawers, with large drawers right, with space-saving siphon and soft close mechanism

Waschtischunterbau, ohne Deckplatte, mit breiten Schubladen rechts, mit 4 Schubladen, mit platzsparendem Siphon und Softclose  
Meuble sous lavabo, sans plaque de couverture, avec 4 tiroirs, avec tiroirs larges à gauche, avec siphon gain de place et mécanisme soft close  
Base sottolavabo, senza piano di appoggio, con 4 cassetti, con cassetti grandi a destra, con sifone salvaspazio e Softclose

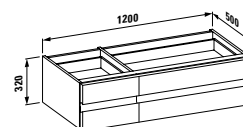
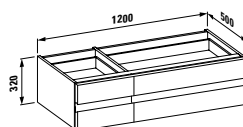

Colours: .630 .631



# ILBAGNOALESSI One



## Top for vanity unit

Deckplatte für Waschtischunterbau

Panneau pour meuble sous lavabo

Piano di appoggio per base de sottolavabo

42462.4

## With cut-out left and right, for one vanity unit with large drawers right and for one vanity unit with large drawers left

Mit Ausschnitt links und rechts, für einen Unterbau mit breiten Schubladen rechts und für einen Unterbau mit breiten Schubladen links

Avec découpe à gauche et droite, pour un meuble sous lavabo avec tiroirs larges à droite et un meuble sous lavabo avec tiroirs larges à gauche

Con taglio a sinistra, per una base de sottolavabo con cassetti largi a destra una base de sottolavabo con cassetti largi a sinistra

## Please state washbasin number in the order form.

Bitte bei der Bestellung die Artikelnummer des Waschtisches vermerken.

Veuillez indiquer le numéro de référence du lavabo lors de la commande.

Al momento dell'ordine annotare il numero di articolo del lavabo.

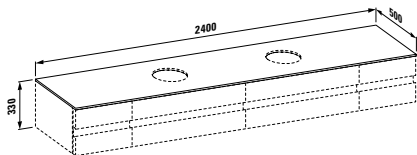

42418.0

## Vanity unit, without top, with 4 drawers, with large drawers right, with space-saving siphon and soft close mechanism

Waschtischunterbau, ohne Deckplatte, mit breiten Schubladen rechts, mit 4 Schubladen, mit platzsparendem Siphon und Softclose

Meuble sous lavabo, sans plaque de couverture, avec 4 tiroirs, avec tiroirs larges à droite, avec siphon gain de place et mécanisme soft close

Base sottolavabo, senza piano di appoggio, con 4 cassetti, con cassetti grandi a destra, con sifone salvaspazio e Softclose

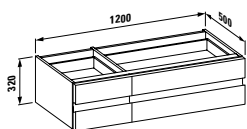

42417.0

## Vanity unit, without top, with 4 drawers, with large drawers left, with space-saving siphon and soft close mechanism

Waschtischunterbau, ohne Deckplatte, mit breiten Schubladen links, mit 4 Schubladen, mit platzsparendem Siphon und Softclose

Meuble sous lavabo, sans plaque de couverture, avec 4 tiroirs, avec tiroirs larges à gauche, avec siphon gain de place et mécanisme soft close

Base sottolavabo, senza piano di appoggio, con 4 cassetti, con cassetti grandi a sinistra, con sifone salvaspazio e Softclose

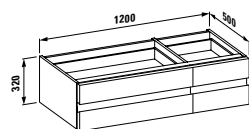

Colours: .630 .631

## Colours furniture

Farben Möbel

Couleurs meubles

Colori dei mobili



### .631 White lacquered

Weiss lackiert

Blanc laqué

Bianco laccato



### .630 Noce canaletto

# ILBAGNOALESSI One



## Tall cabinet with mirror, 4 glass shelves

Hochschrank mit Spiegel, 4 Glasfachböden  
Armoire haute avec miroir, avec 4 étagères en verre  
Colonna con specchio, 4 ripiani di vetro

### 45801.1

#### Door hinge left

Scharnier links  
Charnière de porte à gauche  
Anta con apertura verso sinistra

### 45802.1

#### Door hinge right

Scharnier rechts  
Charnière de porte à droite  
Anta con apertura verso destra

### 45803.1

#### Door hinge left, with illuminated shelving

Scharnier links, mit beleuchteten Ablagen  
Charnière de porte à gauche avec étagères éclairées  
Anta con apertura verso sinistra, con mensole illuminate

### 45804.1

#### Door hinge right, with illuminated shelving

Scharnier rechts, mit beleuchteten Ablagen  
Charnière de porte à droite avec étagères éclairées  
Anta con apertura verso destra, con mensole illuminate

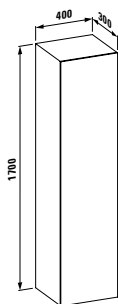

Colours: .630 .631



## Tall cabinet with mirror, 2 glass shelves, 2 interior drawers

Hochschrank mit Spiegel, 2 Glasfachböden, 2 Innenschubladen  
Armoire haute avec miroir, avec 2 étagères en verre, 2 tiroirs intérieurs  
Colonna con specchio, 2 ripiani di vetro, 2 cassetti interni

### 45801.2

#### Door hinge left

Scharnier links  
Charnière de porte à gauche  
Anta con apertura verso sinistra

### 45802.2

#### Door hinge right

Scharnier rechts  
Charnière de porte à droite  
Anta con apertura verso destra

### 45803.2

#### Door hinge left, with illuminated shelving

Scharnier links, mit beleuchteten Ablagen  
Charnière de porte à gauche avec étagères éclairées  
Anta con apertura verso sinistra, con mensole illuminate

### 45804.2

#### Door hinge right, with illuminated shelving

Scharnier rechts, mit beleuchteten Ablagen  
Charnière de porte à droite avec étagères éclairées  
Anta con apertura verso destra, con mensole illuminate

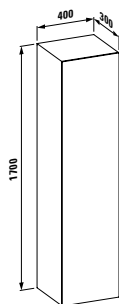

Colours: .630 .631



### 44841.1

#### Mirror, 400 mm, with lighting, mirror frame and anti-misting system, 2x8W, IP44, 230V

Spiegel, 400 mm, mit Beleuchtung, Spiegelrahmen und Anti-Beschlagssystem, 2x8W, IP44, 230V  
Miroir, 400 mm, avec éclairage intégré, cadre et système anti-buée, 2x8W, IP44, 230V  
Specchio, 400 mm, con illuminazione, telaio e sistema antiappannamento, 2x8W, IP44, 230V

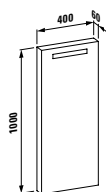

Colours: -



## Mirror, with lighting, mirror frame and anti-misting system

Spiegel, mit Beleuchtung, Spiegelrahmen und Anti-Beschlagssystem  
Miroir avec éclairage intégré, cadre et système anti-buée  
Specchio, con illuminazione, telaio e sistema antiappannamento

	A
44842.1	800, 2x13 W
44843.1	1200, 1x28 W
44844.1	1600, 1x35 W

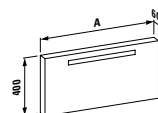

Colours: -

# ILBAGNOALESSI One



**Mirror cabinet, 650 mm, with lighting and anti fog system, 1 x24W, IP44, 230V**

Spiegelschrank, 650 mm, mit Beleuchtung und Anti-Beschlagsystem, 1 x24W, IP44, 230V

Armoire de toilette avec miroir, 650 mm, éclairage intégré, cadre et système anti-buée, 1 x24W, IP44, 230V

Armadietto a specchio, 650 mm, con illuminazione e sistema antiappannamento, 1 x24W, IP44, 230V

44812.1

**Side pull-out right, 1 switch, 1 socket EU**

Seitlicher Auszug rechts, 1 Schalter, 1 Steckdose EU

Tiroir coulissant à gauche, 1 interrupteur, 1 prise UE

Ripiano estraibile a destra, 1 interruttore, 1 presa EU

44812.3

**Side pull-out right, 1 switch, 1 socket CH**

Seitlicher Auszug rechts, 1 Schalter, 1 Steckdose CH

Tiroir coulissant à gauche, 1 interrupteur, 1 prise CH

Ripiano estraibile a destra, 1 interruttore, 1 presa CH

44812.5

**Side pull-out right, no switch, no socket**

Seitlicher Auszug rechts, kein Schalter, keine Steckdose

Tiroir coulissant à gauche, pas d'interrupteur, pas de prise

Ripiano estraibile a destra, senza interruttore, senza presa

44811.1

**Side pull-out left, 1 switch, 1 socket EU**

Seitlicher Auszug links, 1 Schalter, 1 Steckdose EU

Tiroir coulissant à droite, 1 interrupteur, 1 prise UE

Ripiano estraibile a sinistra, 1 interruttore, 1 presa EU

44811.3

**Side pull-out left, 1 switch, 1 socket CH**

Seitlicher Auszug links, 1 Schalter, 1 Steckdose CH

Tiroir coulissant à droite, 1 interrupteur, 1 prise CH

Ripiano estraibile a sinistra, 1 interruttore, 1 presa CH

44811.5

**Side pull-out left, no switch, no socket**

Seitlicher Auszug links, kein Schalter, keine Steckdose

Tiroir coulissant à droite, pas d'interrupteur, pas de prise

Ripiano estraibile a sinistra, senza interruttore, senza presa

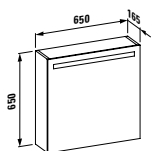

Colours: .630 .631



**Mirror cabinet 800 mm, with lighting and side pull-out left and right, with anti fog system, 1 x24W, IP44, 230V**

Spiegelschrank 800 mm, mit Beleuchtung und seitlichem Auszug links und rechts, mit Anti-Beschlag-system, 1 x24W, IP44, 230V

Armoire de toilette avec miroir, 800 mm, avec tiroir à gauche et à droite, système anti-buée, 1 x24W, IP44, 230V

Armadietto a specchio 800 mm, con illuminazione e ripiani estraibili a sinistra e a destra, con sistema antiappannamento, 1 x24W, IP44, 230V

44823.1

**1 switch, 1 socket EU**

1 Schalter, 1 Steckdose EU

1 interrupteur, 1 prise UE

1 interruttore, 1 presa EU

44823.3

**1 switch, 1 socket CH**

1 Schalter, 1 Steckdose CH

1 interrupteur, 1 prise CH

1 interruttore, 1 presa CH

44823.5

**No switch, no socket**

Kein Schalter, keine Steckdose

Pas d'interrupteur, pas de prise

Senza interruttore, senza presa

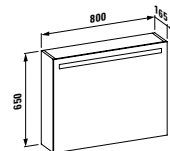

Colours: .630 .631

**Colours furniture**

Farben Möbel

Couleurs meubles

Colori dei mobili



**.631 White lacquered**

Weiss lackiert

Blanc laqué

Bianco laccato



**.630 Noce canaletto**



**It is possible that not all products, sizes or colours are available in every country. Delivery periods may also differ in each case.**

Unter Umständen sind nicht alle Produkte, Grössen oder Farben in jedem Land verfügbar. Auch die jeweiligen Lieferzeiten können von Land zu Land abweichen.

Il se peut que les produits ne soient pas tous disponibles dans chaque pays dans toutes les dimensions et coloris. Les délais de livraisons peuvent également varier d'un pays à l'autre.

È possibile che non tutti i prodotti, le misure e i colori siano ugualmente disponibili in ogni Paese. Anche i tempi di consegna possono variare da un Paese all'altro.

**The illustrated colours only approximately correspond to the actual shades. The bathroom layouts shown here are purely decorative and do not reflect all the technical requirements. The decorative parts used are not included in our commercial offer. We reserve the right to make technical changes without prior notice. Registered design.**

Die Farbabbildungen entsprechen nur in etwa den tatsächlichen Farbtönen. Die hier gezeigten Badmilieus sind rein dekorativ und berücksichtigen nicht alle technischen Anforderungen. Unser Angebot beinhaltet nicht die verwendete Dekoration. Technische Änderungen sind vorbehalten. Design geschützt.

Les photos couleur ne correspondent que partiellement aux teintes effectives. Les ambiances reproduites ici sont simplement décoratives, les exigences techniques d'installation n'ont pas toujours été prises en compte. La décoration utilisée ne fait pas partie de notre offre commerciale. Sous réserve de modifications techniques. Modèle déposé.

I colori qui illustrati non corrispondono esattamente alle tonalità effettive. Gli ambienti qui riprodotti sono puramente decorativi e non tengono conto di tutte le specifiche tecniche. Gli articoli d'arredo usati non fanno parte della nostra offerta commerciale. Con riserva di apportare modifiche tecniche. Modello depositato.

**Printed on certified paper from sustainably managed forests.**

Gedruckt auf zertifiziertem Papier. Aus nachhaltig bewirtschafteten Wäldern.

Imprimé sur du papier certifié. Issu de forêts exploitées de façon durable.

Stampato su carta certificata. Proveniente da boschi a gestione sostenibile.

**Products with the Q-Plus certification comply with the European standard, as well as with the proven higher Swiss standard laid down by suissetec/VSA. LAUFEN ceramic products comply with this Swiss quality standard and are recommended accordingly.**

Produkte mit der Q-Plus-Zertifizierung entsprechen einerseits der Europeanorm und andererseits zusätzlich dem bewährten, höheren Schweizer Standard, welcher durch die suissetec/VSA festgelegt wurde. LAUFEN Keramikprodukte entsprechen diesen schweizerischen Qualitätsmassstäben und haben die entsprechende Zulassungsempfehlung.

Les produits avec certification Q-Plus correspondent à la norme européenne et satisfont en plus aux standards suisses définis par la suissetec/VSA, encore plus élevés et qui ont largement fait leurs preuves. Les produits en céramique signés LAUFEN sont conformes à ces critères de qualité suisses et bénéficient donc des recommandations d'homologation correspondantes.

I prodotti con la certificazione Q-Plus sono conformi sia alla normativa europea sia allo standard svizzero, che prevede requisiti ancora più rigorosi, stabiliti dalla suissetec/VSA. I prodotti in ceramica LAUFEN rispettano questi criteri qualitativi svizzeri e dispongono della relativa certificazione di qualità.

**Il Bagno Alessi is a complete bathroom installation concept that was produced by two of Europe's leading manufacturers in the range of bathrooms: the Swiss LAUFEN (sanitary ceramics, bathtubs, furniture and ceramic accessories) and the Finnish ORAS (fittings).**

Il Bagno Alessi ist ein komplettes Einrichtungskonzept fürs Badezimmer, das von zwei der führenden europäischen Hersteller im Bereich Badezimmer produziert wurde: vom Schweizer LAUFEN (Sanitärkeramik, Badewannen, Möbel und keramische Accessoires) und dem finnischen ORAS (Armaturen).

Il Bagno Alessi est un concept d'aménagement complet pour la salle de bains produit par deux des fabricants d'éléments pour salle de bains leaders européens: le suisse LAUFEN (céramique sanitaire, baignoires, meubles et accessoires en céramique) et le finlandais ORAS (robinetterie).

Il Bagno Alessi è un progetto completo per la stanza da bagno, prodotto da due aziende europee leader nel settore degli elementi per il bagno: la svizzera LAUFEN (ceramiche sanitarie, vasche da bagno, mobili e accessori in ceramica) e la finlandese ORAS (rubinetteria).

**www.alessi.com**  
**www.oras.com**



## SaphirKeramik

**The innovative SaphirKeramik mixture, which is filed for patent, permits the creation of wafer-thin yet robust walls and tight-edged radii of just 1–2 mm (state-of-the-art technology values are currently a minimum of 7–8 mm). The new ceramic is perceptibly sturdier and has greater flexural strength. Its slender profile renders it space-saving, lightweight and environmentally friendly.**

Die innovative und zum Patent angemeldete Rezeptur von SaphirKeramik erlaubt Entwürfe mit hauchdünnen, doch robusten Wandungen sowie eng definierte Radien von nur 1–2 mm (bisher war ein Minimumwert von 7–8 mm State-of-the-Art). Die neue Keramik ist deutlich härter und hat eine grössere Biegefestigkeit. Durch ihr schlankes Profil ist sie platzsparend, leicht und umweltfreundlich.

La formule innovante et précieuse SaphirKeramik, brevet PCT en phase d'approbation, permet de réaliser des arêtes avec un rayon de 1 à 2 mm (jusqu'à présent, une valeur minimale de 7 à 8 mm était considérée comme le nec plus ultra). La nouvelle céramique est nettement plus dure et résistante à la flexion. Grâce à son profil étroit, elle économise d'espace, est légère et écologique.

L'innovativa e pregiata ricetta di SaphirKeramik, brevetto PCT in fase di approvazione, permette di ottenere raggi di soli 1–2 mm (allo stato dell'arte era finora possibile ottenere raggi di 7–8 mm). Questo nuovo tipo di ceramica è notevolmente più duro e possiede una maggiore resistenza alla flessione. Il profilo sottile dona al materiale una maggiore leggerezza, una migliore ottimizzazione degli ingombri e compatibilità ecologica.

**Headquarters:**

LAUFEN Bathrooms AG  
Wahlenstrasse 46  
CH-4242 Laufen  
Tel. +41 61 765 71 11  
Fax +41 61 761 36 60  
feedback@laufen.ch  
www.laufen.com

**Export:**

LAUFEN Bathrooms AG  
Wahlenstrasse 46  
CH-4242 Laufen  
Tel. +41 61 765 76 09  
Fax +41 61 765 77 77  
export@laufen.ch  
www.laufen.com/export

**Asia:**

Roca Sanitaryware Ltd.  
Room 2303, 23/F  
148 Electric Road  
North Point, Hong Kong  
Tel. +852 250 624 38  
Fax +852 250 624 92  
laufenasia@hongkong.laufen.ch  
www.laufen.com/export

**Oceania:****Australia, New Zealand & other**

Roca Bathroom Products  
Australia P/L  
Level 10, Suite 1004  
46 Market Street  
Sydney NSW 2000  
Australia  
Tel. +61 (2) 9290 2331  
Fax +61 (2) 9290 2786  
aus.admin@roca.net  
www.laufen.com.au

**Austria:**

LAUFEN Austria AG  
Mariazeller Strasse 100  
A-3150 Wilhelmsburg  
Tel. +43 2746 6060  
Fax +43 2746 6060 380  
office.wi@at.laufen.com  
www.laufen.co.at

**Bosnia and Herzegovina,  
Croatia, Kosovo, Macedonia,  
Montenegro, Serbia, Slovenia:**

INKER d.d.  
Industrijska 1  
10290 Zaprešić  
Tel. +385 1 3310 364  
Fax +385 1 3310 275  
komercijala@inker.hr  
www.hr.laufen.com

**Benelux:**

LAUFEN Benelux B.V.  
Meidoornkade 2A  
NL-3992 AE Houten  
Tel. +31 (0)33 450 20 90  
Fax +31 (0)33 450 20 91  
info.benelux@laufen.ch  
www.laufen.nl  
www.laufen.be

**Brazil:**

Roca Sanitários Brasil Ltda.  
Av. 14 de Dezembro,  
2.800 - V. Mafalda  
CEP: 13206-105  
Jundiá - SP - Brasil  
PABX: +55 11 3378 4600  
Assistência Técnica: 0800 70 11 510  
Fax +55 11 4587-2324  
info.br@laufen.com  
www.laufen.com/br

**Bulgaria:**

Roca Bulgaria AD  
5, Pirotska Str.  
1301 Sofia, Bulgaria  
Tel. +359 2 930 59 10  
Fax +359 2 930 59 18  
office.sofia@bg.roca.net  
www.bg.roca.com

**China:**

Roca Sanitary Trading  
(Shanghai) co. Ltd  
Room 503-505, City Gateway  
No. 396 North Caoxi Road  
Shanghai 200030, China  
Tel. +86 21 3368 8822  
Fax +86 21 3368 8299  
laufen\_cn@roca.net.cn  
www.cn.laufen.com

**Czech Republic:**

LAUFEN CZ s.r.o.  
V Tűnich 3/1637  
120 00 Praha 2  
Tel. +420 296 337 711  
galerie@cz.laufen.com  
www.laufen.cz

**Estonia, Latvia:**

LAUFEN CZ s.r.o.  
Pae 25-8  
Tallinn, 11414  
Estonia  
Tel./Fax +372 6 215 569  
office.tallinn@ee.laufen.com  
www.laufen.com

**France:**

Roca S.A.R.L.  
Marque LAUFEN  
Immeuble le Rond Point  
5 Boulevard de l'Oise  
F-95015 Cergy Pontoise Cédex  
Tel. +33 1 34 40 39 31  
Fax +33 1 30 37 02 65  
commercial@laufen-france.com  
www.laufen.com/fr

**Germany:**

Roca GmbH  
Vertrieb LAUFEN  
Feincheswiese 17  
56424 Staudt  
Germany  
Tel. +49 26 02 / 94 93 33  
Fax +49 26 02 / 94 93 355  
info.staudt@de.laufen.com  
www.de.laufen.com

**Hungary:**

LAUFEN CZ s.r.o.  
Hungarian Trade Agency  
Pasaréti u. 83  
H-1026 Budapest  
Tel. +36 1 274 05 35  
Fax +36 1 391 04 58  
office.budapest@hu.laufen.com  
www.laufen.com

**India:**

Roca Bathroom Products Pvt. Ltd.  
3rd Floor, Tower B,  
DLF Building No. 10, Phase – II  
DLF Cyber City,  
Gurgaon – 122002, Haryana  
India  
Tel. +91 124 4278347-49  
Fax +91 124 4278350  
Info.laufen@in.roca.com  
www.laufen.com/export

**Italy:**

LAUFEN CZ s.r.o.  
V Tűnich 3/1637  
CZ-120 00 Praha 2  
Tel. +39 02 90016001  
Fax. +39 02 90016011  
www.it.laufen.com  
info@laufen.it

**Lithuania:**

LAUFEN CZ s.r.o.  
Užupio g. 30  
Vilnius, 01203  
Lietuva  
Tel. +370 5 215 30 76  
office.vilnius@lt.laufen.com  
www.laufen.lt

**Morocco:**

Roca Maroc, S.A.  
route de Marrakech, km 2,5  
BP 571, 26000 Settât  
Tel. +212 5 23 40 59 41  
Fax +212 5 23 40 59 42  
www.roca.com

**Nordic Countries:****Denmark, Finland, Sweden**

LAUFEN Nordic Aps  
Tømrenvej 2  
4600 Koge  
Denmark  
Tel. +45 56 287 287  
Fax +45 56 287 237  
info@dk.laufen.com  
www.laufen.dk  
www.laufen.fi  
www.laufen.se

**North America:**

LAUFEN Bathrooms North America  
Showroom  
7610 NE 4th Court, Suite 104  
Miami, FL 33138  
USA  
Toll free phone +1 (866) 696-2493  
+1 (305) 357-6130  
Toll free fax +1 (866) 628-1760  
usa@laufen.com  
canada@laufen.com  
www.laufen.com/usa  
www.laufen.com/ca  
www.laufen.com.mx

**Norway:**

Laufen Norge AS  
Syretårnet 41  
NO-3048 Drammen  
Tel.: +47 32 27 60 70  
firmapost@no.laufen.com  
www.laufen.no

**Poland:**

Roca Polska Sp. z o.o.  
ul. Wyczółkowskiego 20  
44-109 Gliwice  
Tel. +48 32 339 41 00  
Fax +48 32 339 41 01  
biuro@roca.pl  
www.laufen.pl

**Portugal:**

Roca, S.A., Portugal  
Apartado 575, Ponte da Madalena  
2416-905 - Leiria, Portugal  
Tel. +351 244 720 000  
Fax +351 244 722 373  
marketing.le@pt.roca.net  
www.laufen.pt

**Romania:**

Roca Obiecte Sanitare S.R.L.  
Blvd. Preciziei nr. 1, Sector 6  
062202 - Bucharest - Romania  
Tel. +4031 822 2310  
Fax +4021 318 1418  
www.ro.roca.com

**Russia:**

Roca Rus  
Promyshlennaya Str. 7, Tosno  
Leningrad region, 187000, Russia  
Tel. +7 812 347 94 49  
Fax +7 812 347 94 50  
marketing@ru.roca.net  
www.laufen.ru

**Roca Rus**

2nd Hutorskaya, 38A, building 14  
Moscow, 127287, Russia  
Tel. +7 495 989 65 91  
Fax +7 495 959 65 93  
marketing@ru.roca.net  
www.laufen.ru

**Slovakia:**

LAUFEN SK s.r.o.  
Štefanovičova 12,  
811 04 Bratislava  
Tel. +421 2 52 621 024  
www.sk.laufen.com

**Spain:**

Laufen Bathrooms S.A.  
C/Covarrubias 23  
28010 Madrid  
Spain  
Phone: +34 900 103 258  
info@es.laufen.com  
www.laufen.com/es

**Sweden:**

Laufen Sverige AB  
Kämpegatan 15  
SE-41104 Göteborg  
Tel. +46 (0) 823 44 44  
info@se.laufen.com  
www.laufen.se

**Switzerland:**

Keramik Laufen AG  
Wahlenstrasse 46  
CH-4242 Laufen  
Tel. +41 61 765 71 11  
Fax +41 61 761 29 22  
forum@laufen.ch  
www.laufen.ch

**Ukraine:**

LAUFEN CZ s.r.o. Ukraine  
Kiev 04128  
19, Ak. Tupoleva str., office „Laufen“  
Tel. +380 44 499 0620  
Fax +380 44 499 0621  
office.kiev@ua.laufen.com  
www.laufen.net.ua

**United Kingdom and Ireland:**

LAUFEN Ltd.  
c/o Roca Ltd.  
Samson Road  
Hermitage Industrial Estate  
Coalville  
Leicestershire  
LE67 3FP  
Tel. +44 (0)1530 510007  
Fax +44 (0)1530 838949  
info@uk.laufen.com  
www.uk.laufen.com



Art Direction / Graphic Design RADL, Milano – Photos Tiziano Alderighi with Camilla Brighi  
Print Grafiche Antiga – Thanks to: B&B Italia, Gabel, Kasthall, MDF Italia, Muji, My fragrances, Oras



**LAUFEN Bathrooms AG**  
Wahlenstrasse 46  
4242 Laufen, Switzerland  
[www.laufen.com](http://www.laufen.com)

ALESSI is a registered trademark of  
ALESSI S.p.A. 28887 Crusinallo (VB), Italy.  
All products of ILBAGNOALESSI are  
produced under license of ALESSI S.p.A.  
[www.ilbagnoalessi.com](http://www.ilbagnoalessi.com)

**LAUFEN**

T.0015.I.001.403.1/Antiga/06.2016